

## J&M's Integrated Helmet Headset for the Nolan N-43 Installation Instructions

1) Unsnap and peel back both the left and right side cheek pad portion of the helmet's interior liner. Pull the helmet straps through the liner to access the cheek pad bases. **(Figure A.)**

2) Remove left and right side styrofoam cheek pad base. **(Figure B.)**

3) Carefully remove the small cover from the left side of the helmet by lifting the outside tab and pushing it out from the inside. **(Figure C.)**

4) Install the J&M sidecover assembly by first routing the 2 longer speaker wires through the small rectangular opening at the rear of the recessed area and routing the microphone lead through the front rectangular opening **(Figure D.)** then finish installing the J&M sidecover assembly onto the helmet by first inserting the rear of the assembly into the helmet and then press firmly on the front of the assembly to snap it into place. **(Figures E and F.)**

5) Using provided clamp and screw, secure boom mike by inserting screw through clamp and into threaded hole **(Figures G and H.)** DO NOT TIGHTEN

6) Adjust boom mic positioning so that the microphone lines up with the center of the wearers mouth. **(Figure I.)** Finish tightening screw to secure boom mic in place (DO NOT OVER-TIGHTEN)

7) Plug connector on microphone into microphone lead on side cover assembly.

8) Using a modeler's knife, remove a small portion of styrofoam from the left side cheek pad base as shown in **(Figure J.)** so that it will seat properly against the helmet shell when reinstalled over boom mike assembly.

9) Place one of the speakers into the right styrofoam cheek pad base and re-install it into the helmet. Plug the wire from this speaker into the longer of the two wires from the electrical socket assembly. Tuck the remainder of the wire between the padding and the helmet shell with the provided wooden tool. **(Figure K.)**

10) Duplicate step 10 for the left side speaker installation, using the shorter of the two speaker wires from the electrical socket assembly. Replace right and left cheek pad portions of the helmet interior into correct position.

11) Pull the small or medium foam windsock over the microphone, so that the contoured portion of the foam is directly over the position on the microphone that is spoken into.

NOTES: When plugging in the right angle hook-up cord, it may be necessary, especially the first time, to press a little harder than usual (do not twist) to make sure that the connection is fully made.

When using your intercom system, it is important to turn the intercom volume level high enough for comfortable conversation, but not any higher. Unnecessarily high intercom volume levels will only increase the unwanted wind and background noise that you may experience.

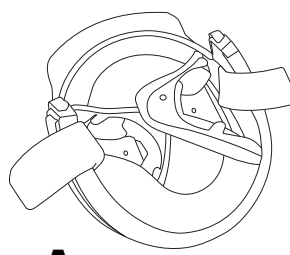

Fig. A

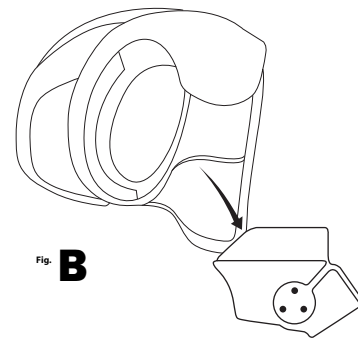

Fig. B

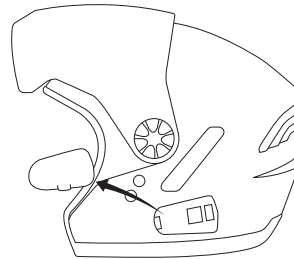

Fig. C

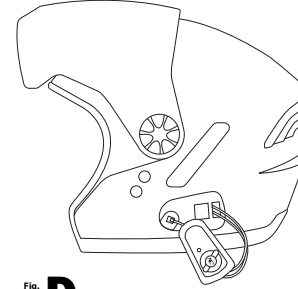

Fig. D

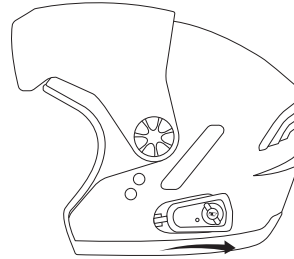

Fig. E

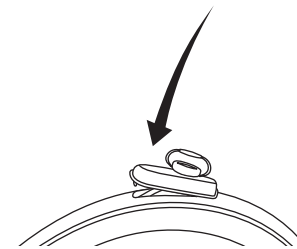

Fig. F

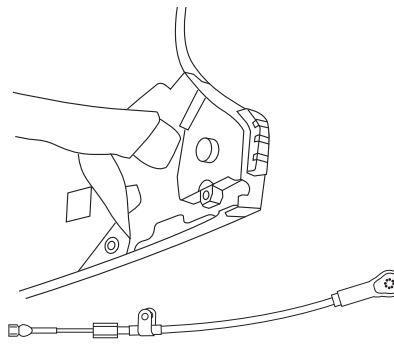

Fig. G

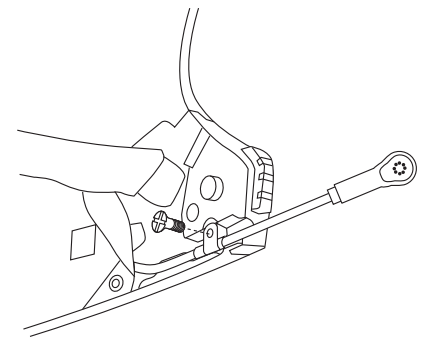

Fig. H

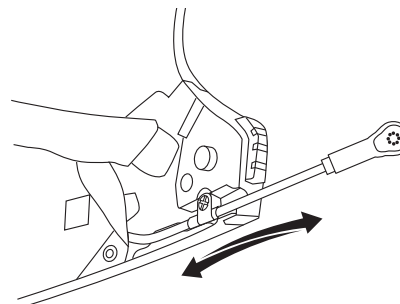

Fig. I

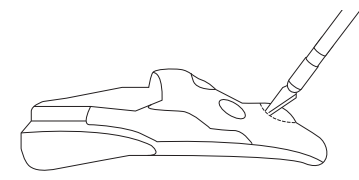

Fig. J

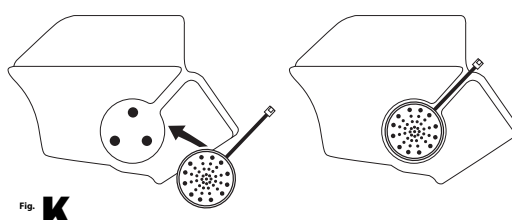
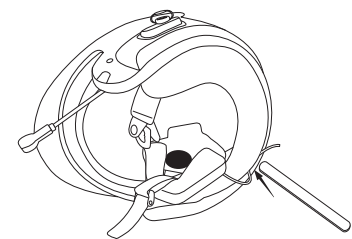

Fig. K



### WARRANTY REGISTRATION FORM

Please fill out this card completely and mail it immediately after purchase. Please be sure that your zip code and serial number (if applicable) are legible. This will help us to serve you better.

(PLEASE PRINT)

Name \_\_\_\_\_

Address \_\_\_\_\_

City \_\_\_\_\_ State \_\_\_\_\_ Zip \_\_\_\_\_

Motorcycle  Other  E-mail \_\_\_\_\_

Make \_\_\_\_\_ Model \_\_\_\_\_ Year \_\_\_\_\_

Product part number \_\_\_\_\_

Serial number (if applicable) \_\_\_\_\_

Date of purchase \_\_\_\_\_

Name of dealer it was purchased from \_\_\_\_\_



Mail to:  
J&M Corporation  
1415 S. Cherry Avenue  
Tucson, AZ 85713-1997

### WARRANTY AND REPAIR INFORMATION

**TWO YEAR LIMITED WARRANTY** In order to facilitate the servicing of this warranty, the Warranty Registration Form should be filled out and returned within 10 days of the date of purchase. However, return of the Warranty Registration Form is not a precondition of this warranty, and this Warranty will be observed by **J&M CORPORATION** whether or not the Warranty Registration Form is returned, on the condition that other satisfactory evidence of the date of the original purchase is provided to **J&M CORPORATION**.

**WHO PROVIDES THE WARRANTY?** This warranty is provided by **J&M CORPORATION**.

**WHO IS PROTECTED?** This warranty is extended only to the original owner of this **J&M CORPORATION** product and may not be transferred or assigned.

**WHAT IS COVERED AND HOW LONG?** This warranty covers all defects in material or workmanship of our product for a period of 2 years from date of original retail purchase. At its option, **J&M CORPORATION** will repair or replace any defective part(s) or equipment.

The provisions of the warranty shall not apply to any unit which has been subjected to misuse, neglect, incorrect mechanical or electrical installation, unauthorized modifications, accident, nor to units which have been repaired or altered outside of our factory.

**PROCEDURE FOR OBTAINING PERFORMANCE OF WARRANTY** In the event that the product does not conform to this warranty, the product should be shipped prepaid to the **J&M CORPORATION** service facility. Transportation charges, insurance fees, and labor costs for shipment, removal, or reinstallation of our product are not covered by this warranty. Loss or damage in shipment is the sole responsibility of the freight carrier.

**FOR YOUR INFORMATION** Repair as provided under this warranty is the exclusive remedy of the consumer. **J&M CORPORATION** shall not be liable for any incidental or consequential damages or for breach of any express or implied warranty on this product. Except to the extent prohibited by applicable law, any implied warranty of merchantability or fitness for a particular purpose on this product is limited in duration to the duration of the warranty. Some states do not allow the exclusion or limitation of incidental or consequential damages, or allow limitations on how long an implied warranty lasts, so the above limitations or exclusion may not apply to you. This warranty gives you specific legal rights which vary from state to state.

**J&M CORPORATION** reserves the right to make changes in design and to make improvements in its products without the obligation to incorporate the changes or improvements in any of its previously manufactured products.

**J&M CORPORATION** has not authorized anyone to make representations or warranties other than the warranty contained herein. The above warranty is effective for all products manufactured after 10/01/86.

**NON-WARRANTY REPAIR RATES** **J&M CORPORATION** reserves the right to change the labor repair rates without prior notice. At the time of this printing the out-of-warranty repair is \$40 per hour for labor only. However, the customer is advised to verify the current rate when he/she calls customer service to obtain the return authorization number.

**FACTORY SERVICE ADDRESS** J&M Corporation, Tucson, Arizona, U.S.A. Tel: 1-800-358-0881 audio@jmcorp.com www.jmcorp.com

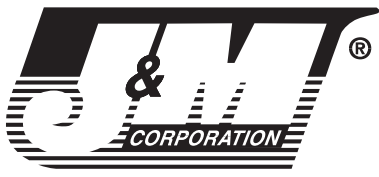

## J&M's Integrated Helmet Headset for the Nolan N-103 Installation Instructions

1) Remove completely both the left and right side interior cheek pads. **(Figure A.)** (Please consult Nolan owner's manual for proper cheek pad removal procedures.) Remove perforated speaker hole from each cheek pad.

2) Remove left and right side styrofoam cheek pad base. **(Figure B.)**

3) Carefully remove the small cover from the left side of the helmet by lifting the outside tab and pushing it out from the inside. **(Figure C.)**

4) Install the J&M sidecover assembly by first routing the 2 longer speaker wires through the small rectangular opening at the rear of the recessed area and routing the microphone lead through the front rectangular opening **(Figure D.)** then finish installing the J&M sidecover assembly onto the helmet by first inserting the rear of the assembly into the helmet and then press firmly on the front of the assembly to snap it into place. **(Figure E and F.)**

5) Using provided clamp and screw, secure boom mike by inserting screw through clamp and into threaded hole **(Figure G & H.)** DO NOT TIGHTEN

6) Adjust boom mic positioning so that the microphone lines up with the center of the wearers mouth. **(Figure I.)** Finish tightening screw to secure boom mic in place (DO NOT OVER-TIGHTEN)

7) Plug connector on microphone into microphone lead on side cover assembly.

8) Place one of the speakers into the right styrofoam cheek pad base and re-install it into the helmet. Plug the wire from this speaker into the longer of the two wires from the electrical socket assembly. Tuck the remainder of the wire between the padding and the helmet shell with the provided wooden tool. **(Figure J. and K.)**

9) Duplicate step 9 for the left side speaker installation, using the shorter of the two speaker wires from the electrical socket assembly. Replace right and left cheek pad onto base.

10) Pull the small or medium foam windsock over the microphone, so that the contoured portion of the foam is directly over the position on the microphone that is spoken into.

NOTES: When plugging in the right angle hook-up cord, it may be necessary, especially the first time, to press a little harder than usual (do not twist) to make sure that the connection is fully made.

When using your intercom system, it is important to turn the intercom volume level high enough for comfortable conversation, but not any higher. Unnecessarily high intercom volume levels will only increase the unwanted wind and background noise that you may experience.

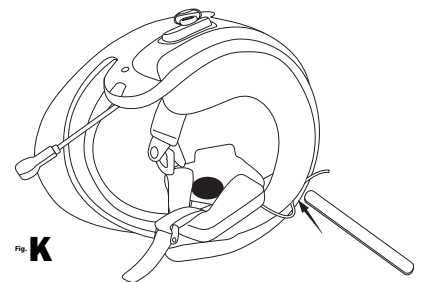
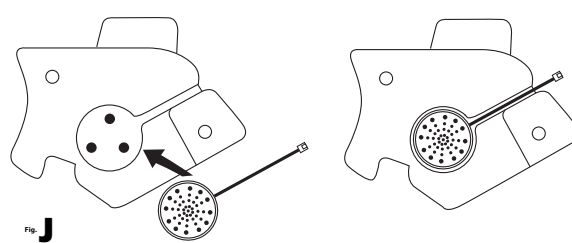
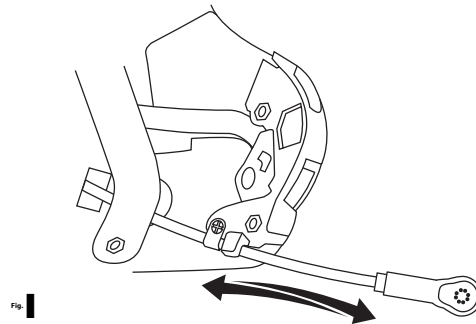
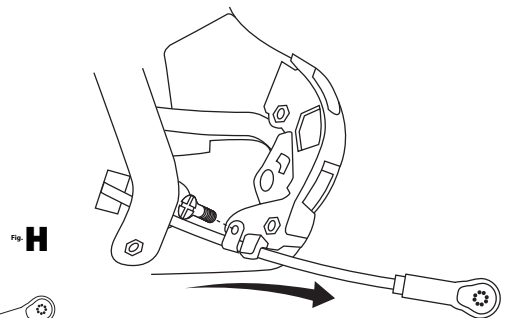
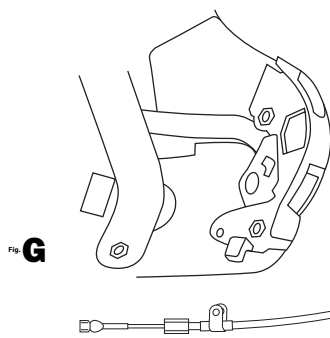
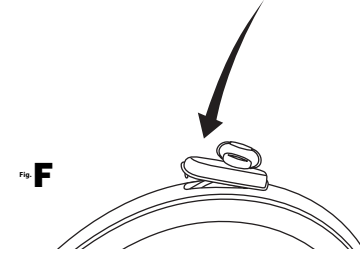
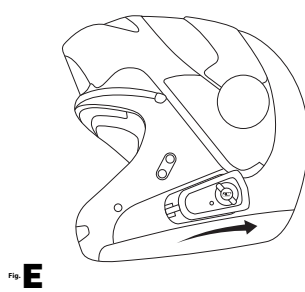
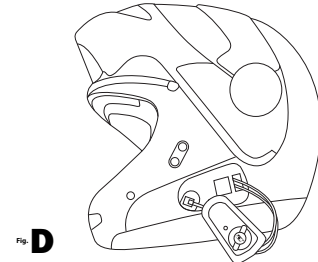
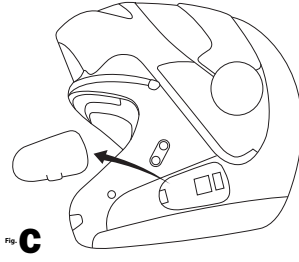
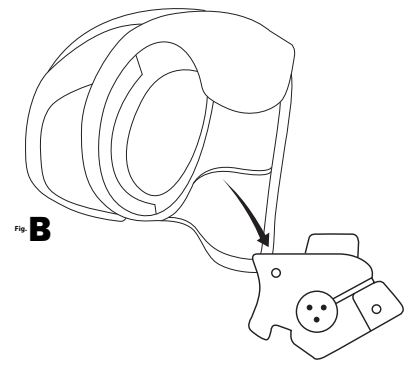
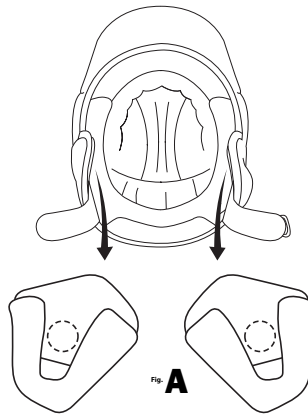

• **Thank you** for the confidence you have shown in J & M by purchasing one of our innovative products. It will give you many hours of riding pleasure. If you have any questions during installation or require more information about this product, you may call our Customer Service Department (English only, please) at (800) 358-0881, Monday through Friday, 8:00 a.m. to 5:00 p.m. Mountain Standard Time, U.S.A.

### Audio Specifications

Speaker impedance . . . . . 50 Ω ± 10%  
Microphone impedance . . . . . 250 Ω ± 10%

Please complete  
WARRANTY REGISTRATION FORM  
on the reverse side and send to J&M Corporation

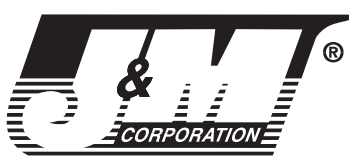

**J&M Corporation**  
Tucson, Arizona, U.S.A.  
Tel. 1-800-358-0881  
www.jmcorp.com  
audio@jmcorp.com