

Add On ACCESSORIES®

2017



We Are Everything Goldwing!

Notice

The parts in this catalog are intended for aftermarket use only. We have no connection with the Honda Motor Company® or Harley Davidson® Incorporated or Bombardier Recreational Products Inc.® and all words, terms and letters are used for reference only. Add On Accessories ® distributes products from many sources.

The parts in this catalog must be installed by a qualified mechanic in accordance with the original equipment manufacturer's service manual. All parts should be inspected by a qualified mechanic before installation. It is important that the proper part be selected for a specific purpose. All parts must be maintained in accordance with the O.E.M. service manual. Add On Accessories ® can not be held responsible for any damage or injury of any kind because of misuse or the improper installation of any parts by any person in any way.

Add On Accessories ® sells to legitimate dealers and accessory outlets and does not sell retail. Dealers are free to establish their own pricing and policies.

Add On Accessories ® reserves the right to change specifications, product descriptions, product quality, pricing and applications at anytime without notice and without further obligation. Check with your supplier for availability and pricing before ordering. **All pricing is subject to change without notice.**

Special Orders. Any item that has been special ordered cannot be returned to Add On Accessories ®

Warranty/Returns Add On Accessories ® will only accept returns on defective merchandise 60 days from the day of purchase from the dealer who purchased the part. Exceptions: No returns on electrical parts or lighting. Returns on defective parts from J&M Corporation®, MC Enterprises®, Progressive Suspension® and SoCal® will be done directly with the manufacturer for replacement only. No returns on parts that were special ordered items. **All returns will go through the dealership it was purchased from.**

Copyright 2017 by Add On Accessories ®, Worcester, MA. All rights reserved. No part of this catalog may be reproduced without written permission of Add On Accessories ®.

Add On Accessories®
133 Gold Street
Worcester, MA 01608
Phone: 508-791-7552
Toll Free: 800-821-9861
Fax: 508-793-2919
Email: info@addonaccessories.net
Web: www.addonaccessories.net



GL1800

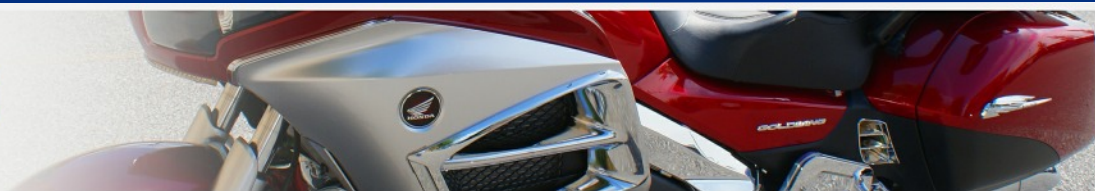

45-1202 1800 Chrome Rotor Covers \$134.95

Tri-chromed ABS rotor covers add beauty and provide protection to the front wheel. Fits all GL1800 except airbag models. Pair.



Part	Description	Price
45-1222A	Amber LED Rotor Cover Light Rings	\$ 76.95
45-1222RB	Red Blue Amber Rotor Cover Light Rings	\$ 104.95
45-1222A-A	Replacement Amber LED Light Strip Pair L&R	\$ 69.95
45-1222RB-A	Replacement RBA Strip Lights Only Pair L&R	\$ 71.95

18-625A Caliper Cover Light Kit \$42.95

Replace the reflector on the caliper with this LED amber light encased in a chrome frame. Fits all GL1800 and GL1200 84-87 Side Marker Light.

Optional:

45-1227A Amber LED Lights.

Pair. \$21.95

45-1100 Chrome Grills \$14.95

Pair.



45-1100

Chrome LED Rotor Cover Light Rings Chrome ABS light ring trim contains 40 LED lights per side. Attaches to rotor covers with screws. Fits all GL1800. Pair.



45-1222A



45-1222RB

45-1293 GL1800 Chrome Fork Covers \$165.95

Beautiful tri-chromed ABS Fork Covers are direct replacements for the gray O.E.M covers. Their unique grill design matches the lines of the bike as well as other chrome pieces on the bike. Amber reflectors are included. Fits all GL1800 except airbag models. Pair.

Optional:

45-1227 Amber Reflector Replacement with black housing. Pair. \$15.95



45-1293L GL1800 Lighted Chrome Fork Covers \$207.95

These beautiful tri-chromed ABS Fork Covers are direct replacements for the gray O.E.M covers. Their unique design matches the lines of the bike and other chrome pieces on the bike. Included are amber LED lights to add light to the front of the bike. Fits all GL1800 except airbag models. Pair.

LED Fork Light Kit \$128.95

This LED light kit consists of 6 LED chrome courtesy lights and 6 chrome housings which attach to the caliper cover. A great light accent to the front wheel creating more front visibility to oncoming traffic or a great addition to any show bike. Requires drilling. Available in 6 color kits. Fits all GL1800s. Set of 6.

Part	Colors
18-113A	Amber
18-113F	Multi colored, continual flashing
18-113L	Blue
18-113R	Red
18-113W	White
18-113RAL	Red Blue Amber



18-113A

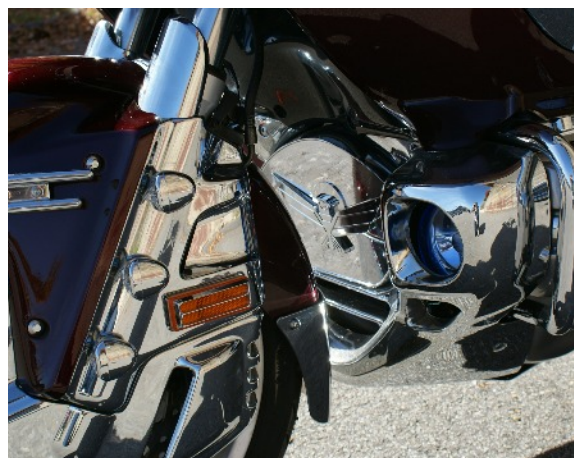

GL1800

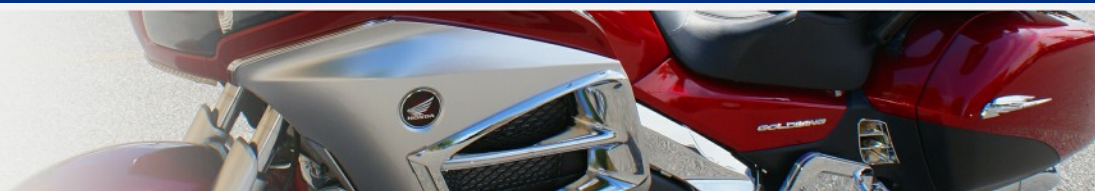

GL1800 01-10 LED Fog Lights with Running and Turn Signals \$329.95



NEW All in one fog lights have integrated daytime running and turn signals (DRTS) with powerful LED. The fog lights produce a clean white light controlled independently from the DRTS. Day time running lights are white and remain on when there is power to the motorcycle and turn amber when turn signals are activated. Fits the GL1800 2001-2010 and F8C Valkyrie with original or chrome cowl with round cutouts. Plug N Play, includes hardware, lights, relay switch, wire harness and instructions. Mounts and installs to existing OEM pre-drilled holes and not the cowl. F8C Valkyrie – The running light functions but not the turn signal. Mean Lumens 420LM. Pair.

Part	Description
45-1860	GL1800 2001-2010
45-1860AB	GL1800 2001-2010 Airbag models
45-1850-R	Replacement Relay



GL18RFL LED Fog Lights with Running and Turn Signals \$299.95

The rectangular fog lights are an all-in-one design and include a single projector with High Definition optics and advanced LED fog lights. They also have a separate built in LED light with a switchback system allowing these LED lights to function as white daytime running lights (DRL) and change to an amber blinking turn signal when activated. Fits the 2012 and up GL1800, F6B and Valkyrie with new cowls and rectangular cutouts. Lumens: 90-450LM Amber/White. Pair.



LED Fog Lights \$299.95

These super bright LED driving lights will definitely light up the road ahead. The lights fit behind the cowl and go through the knock outs. The lens measures 3 3/4 inches in diameter. They are 12 volt, 6 watts and the LED has a lumen of 4500 cd and is amazingly bright. The unit is plug-and-play and comes with a relay and jumper plugs. If the relay is used the kit will function as OEM and the fog lights will turn off with the high beam. If the jumper plug is used, the fog lights will work with both low and high beam headlights. The lights have a clear lens and a beautiful chrome bezel encased inside the sealed light housing. All wiring, switches, hardware and instructions are included. Pair.

Part	Description
45-1850	GL1800 2001-2010
45-1850AB	GL1800 2001-2010 Airbag models



45-1850-R Replacement Relay \$9.95

Works on both 45-1850 and 45-1850AB.



18673-221A Xenon Blue Driving Lights Kit \$99.95

An economically priced driving light with 55 watt high output halogen bulbs, relay switch and wiring kit. The lights fit behind the cowl and add extra light to the road ahead. Fits the GL1800 but works best with cowls with a round cutout. Pair.

Replacement Parts:
KY-938-2LK Lights only, pair. \$65.95

01-H3 12V/55W Bulb
 \$9.95



GL1800

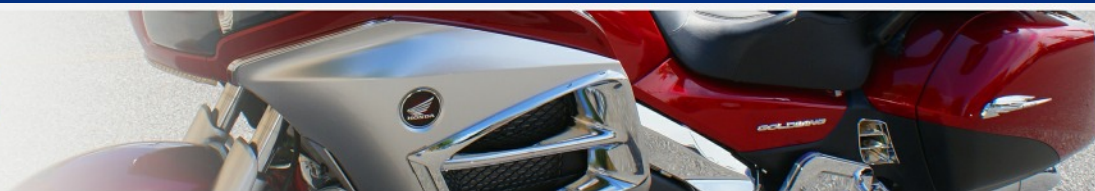

Front Fairing Halo

Chromed ABS trim fits under the headlights and front fairing. It will light up the inside area under the front fairing, top of the fender and forks with a halo of color from the 40 LED lights. It has a 10 inch lead wire and hardware to mount. Fits all GL1800. Single.

Part	Description	Price
45-1222H	Amber	\$ 39.95
45-1222RBH	Red Blue Amber	\$ 51.95



45-1222H

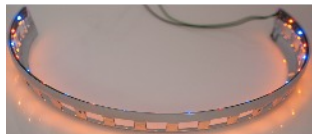

45-1222RBH

45-1231 Chrome LED Lighted Eagle Ornament A redesigned front fender ornament with LEDs to light the eyes and front of the eagle. The eagle has smoother lines and more pronounced features. Fits all GL1800s and many other large fenders with this curve. Measures 6 1/2 inches, front 1 3/8 inches, back 4 1/2 inches Single.



18260 Front Fender Fillers \$29.95

By V&P Ent and made in the USA. This polychrome plate fills the holes of the front fender to prevent dirt and water from coming through helping to protect the fender and paint. Uses self-adhesive tape to mount. Fits all GL1800 bikes. Pair.



Replacement LED Headlight Bulb Plug and play. Fits GL1800 and F6B. Works for both Low and High beam. Pair.

Part	Description	Price
G18LEDH	High and Low Beam 4800 lumens	\$110.00



Replacement Headlight Bulb Sold single, these are 12V/55W headlight bulbs.

Part	Description	Price
01-48328	Standard	\$14.95
01-48638	Xenon Super	\$29.95



01-48328

01-48638

45-1621NU Timing Chain Cover with Eagle \$74.95

This beautiful eye catching chrome ABS timing chain cover comes with a detachable eagle emblem to provide access to the timing chain nut. Installs in minutes using thick adhesive tape. The removable eagle is held on with a very strong, industrial strength Velcro. Fits the Goldwing GL1800. Single.

Replacement eagle, Add On part

45-1621NU-E \$19.95



45-1621NU-E



45-1244 LED Front Fender Trim \$75.95

A one piece amber LED lighted front fender trim is made of chromed ABS and provides additional lighting for more visibility to the front and sides. There are eight super bright LED amber lights on each side encased in chrome. Easy to install with self adhesive tape, no drilling required and works as a running light. Fits the GL1800. Single.



45-1204 Chrome Front Fender Extension \$29.95

This tri-chromed front fender extension is 2 inches longer than stock providing extra protection for the front of the bike. Fits all GL1800 except airbag models. Single.



18269 Tunnel Filler \$19.95

These foam tunnel fillers fit around the top of the forks and prevent air flow onto the driver for a more comfortable ride during hot, cold or rainy weather. They also keep road debris from blowing up onto the driver. Made in the USA. Fits the GL1800 01-10. Pair.



GL1800

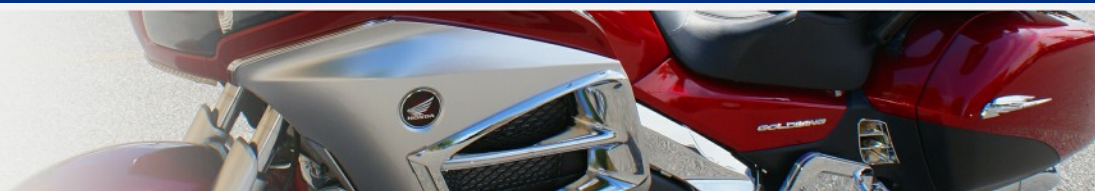

45-1299 Chrome Headlight Contour Cover Trims \$45.95

This tri-chromed ABS accent goes over the OEM black contour areas at the rear of the headlights and follows the lines and curves of the bike. Installation is very easy using double sided tape and best of all, no disassembling to put them on. The chrome adds a nice touch onto the front of the bike. Fits the Goldwing GL1800 12 & up. Pair.

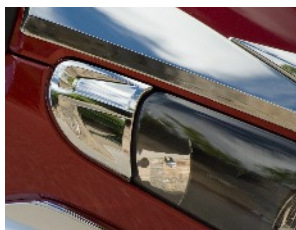

45-1207N Chrome Fairing Intake Grills \$34.95

These tri-chromed ABS grills add a touch of chrome and beauty to the outside fairing. Easy to install by just snapping in. Fits GL1800 01-10. Pair.



45-1298 Chrome Headlight Side Trims \$45.95

This accent is made of tri-chromed ABS and covers the lip that runs along the outside front fairing under the headlights. These small chrome accents add definition to this area of the bike and compliment other chrome pieces nicely. Easy to install with double sided tape. Fits the Goldwing GL1800 12 & up. Pair.

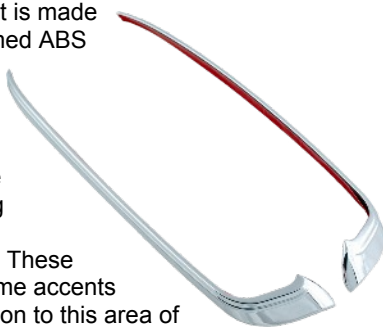

Chrome Headlight Contour Cover Trims with LEDs \$84.95

Headlight contour trims are chromed ABS and contain 8 LED lights for each side. When the lights are off, they appear to be a solid chrome piece. They easily mount over the OEM black headlight cover with self adhesive tape. The lights have dual function as running and turn signals. Fits the GL1800 12 & up. Pair.

Optional:

45-1299-W Wire Connector \$6.95 Connector to splice or tap two wires together. Snaps together for a secure hold. Made for 22-26 gauge wire. 10 Pack.

Part	Description
45-1299ALED	Amber
45-1299WLED	White



45-1299-W



45-1299ALED



45-1299WLED

Side Emitting LED Strip Lights \$60.95

Side emitting flexible LED strip lights are super thin and flexible making them perfect for a large variety of lighting applications. The unique right angle mounted LED's focus light at a 90° angle making them more visible. The waterproof lights each have 48 LEDs encased in a black soft flexible housing. Great for accents around headlights, along fairing edges, above motors and are a great fit into tight areas of the bike, trike or trailer. They can be cut for customized applications between the copper connectors. They measure 19 inches in length, 3/16 inches wide and less than 1/16 inch in depth with a 35 inch heavy duty gauge lead wire and uses 3M adhesive tape to mount. Single function light. Left and right pair.



Part	Color
335A48	Amber
335B48	Blue
335G48	Green
335R48	Red
335W48	White

45-1205B Windshield or Front Fairing Garnish \$26.95

This amber LED strip light is both versatile and extremely flexible allowing it to be used in many places on a bike, trike or trailer. It contains 30 LEDs in a clear housing, measures 12 inches in length and has a 40 inch lead wire. The light can be connected together to obtain any length desired and uses self-adhesive tape to mount. The light has a two-wire function to work as a running, brake or turn signal light. Add On uses this light in the windshield vent and on the front fairing of the GL1800. Single.



GL1800

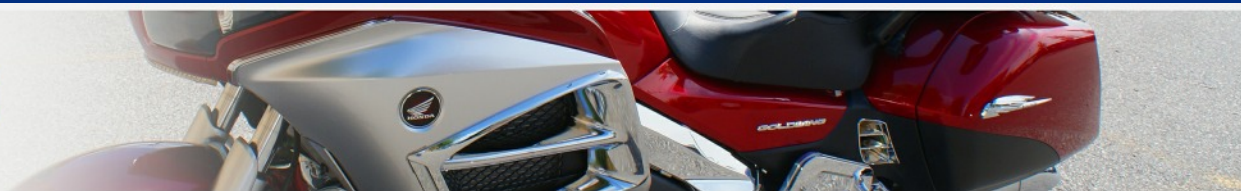

1801 Adjustable Wind Deflectors \$82.95

By V&P Inc. and made in the USA. This Lexan wind deflector fits most 12 inch standard windshields. Adjustable wing allows the control of air flow. Requires drilling to mount. Fits the GL1800. Pair.



20-64B2 Amber Windshield Edge Lights \$59.95

These lights add a glow of amber on the edge of the windshield making the bike more visible and easier to be seen at night. The light attaches with chrome channels and set screws at any desired part of the windshield. (May not work on aftermarket windshields.) Each kit has two strip lights containing 9 amber LEDs each, chrome channels measuring 5 inches with a 1/4 inch opening for the strip light and a 36 inch lead wire. Functions as a running light. Pair.



45-1294 Windshield Panel Accents \$124.95

These tri-chromed ABS accents will add a dramatic distinctive look to the bike. The part follows the contour of the windshield's outer edges while still allowing the color of the bike to be exposed. They also help to cover weather worn or damaged panels. Attaches with self-adhesive tape. This part can be used with other chrome accents like Add On Part 45-1295, Chrome Mask. Fits GL1800 12 & up. Pair.



45-1252N Windshield Vent \$51.95

This tinted replacement windshield vent has adjustable louvers and a lever to direct the flow of air on the driver. They fit in the GL1800 O.E.M. and many aftermarket windshields. Included are chrome bolts to give the part a finished look. Single.



45-1205-L Windshield Panel Light \$29.95

This amber LED light illuminates the opening vent in the windshield panel with 20 super bright LEDs adding additional light and visibility to the front of the bike. Fits GL1800 01-10. Single.



18273 Windshield Panel Light Reflector \$9.95

By V&P Ent. and made in USA of polychrome. Helps to enhance light reflection from any light in the windshield panel vent. Easy to install with self-adhesive tape. Fits the GL1800 01-10. Single.



45-1242 Chrome Windshield Vent Accent Trim \$40.95

This popular ABS tri chromed accent is a great way to add a touch of chrome to the windshield. This trim outlines the windshield vent and very easily attaches with self adhesive tape. Fits the GL1800 04 & up. Single.



LED Lighted Eagle Emblem

This unique modern looking eagle has 14 super bright amber LED lights and works as a running and turn signal light. The eagle has a slight curve to fit on many surfaces such as the windshield panel or trunk and uses self-adhesive tape to mount. Measures 7 inches x 2 inches. Single.

Part	Color	Price
45-1240LED	Chrome	\$69.95
45-1240GLED	Gold	\$79.95



45-1240LED



45-1240GLED



45-1295 Windshield Panel Mask Accent \$81.95

This tri-chromed ABS accent adds a dramatic look to the front face of the bike. The part follows the front contours of the windshield panel and still allows the color of the bike to be exposed. It also helps to cover weather worn or damaged panels and looks great with other chrome accents. Easy to install with adhesive tape. Fits the Goldwing GL1800 12 & up. Single.



GL1800

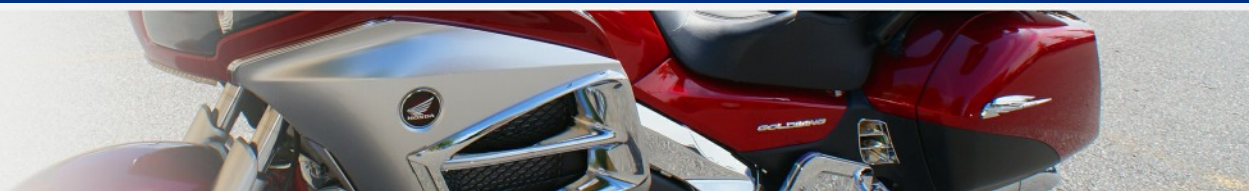

45-1698 Side Fairing Logo Accents \$104.95

These tri-chromed accents bring out the bike's great contours on the front fairing. The part completely encircles the bike logo so it is still exposed. Easy to install with adhesive tape. A perfect fit with Add On part 45-1696, chrome air intake accents. Fits the GL1800 12 & up. Pair.



45-1696 Chrome Air Intake Accents \$121.95

These tri-chromed ABS side fairing accents are gorgeous and stylish. They make the outside fairing really pop with chrome and follow the contours of the bike. They install with tape and silicone for a secure fit. Fits the GL1800 12 & up. Pair.



BP-2 Engine Plate \$52.95

Made of aircraft aluminum and includes stainless steel screws. The two piece design allows oil changes to be done without removing the cowl. Protects the underside of the bike and keeps it cleaner. The ram flow nose piece improves cooling. Fits the GL1800. Single.



45-1694A Chrome Logo Accent with Amber LED Side and Turnsignal Lights \$108.95

These chrome ABS pieces cover the area over the logo on the outside of the bike fairing. Each has 12 amber LED lights that work as running and turn signal. Use the OEM logo (not included) or any other piece for the center area. Easy to install, no drilling required. Fits the GL1800 12 & up. Pair.



45-1631 Chrome Radiator Grills \$94.95

These beautiful chrome ABS radiator grills are a great way to brighten up the sides of the bike. They are light weight and replace the OEM black grills on the bike. Fits the GL1800 06-10. Pair.



45-1637 Chrome Case Guards \$179.95

Chrome steel replacement case guards are beautiful and economically priced. They fit great and are a direct OEM replacement. A phenomenal price and great quality. Fits the GL1800s. Pair.



1804 Front Rain Deflectors \$79.95

Made by V&P Ent and made in the USA. Made of clear Lexan, these wind and rain shields protect the rider from the elements of rain, cold and road debris. The front deflectors are for use with highway boards. Fit all GL1800. Pair.



GL1800

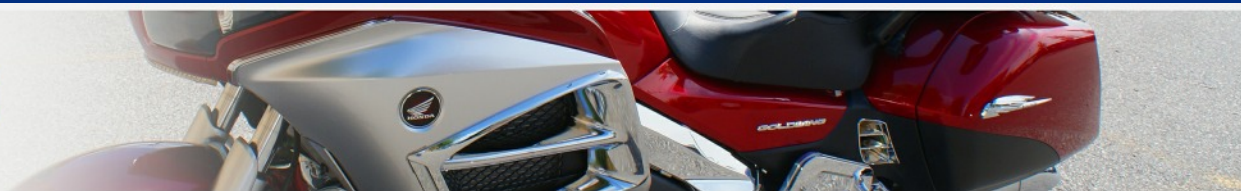

45-1629NUA Predator® Grills \$45.95

These tri-chromed ABS grills are a beautiful addition to the side fairing. The 4 piece grill fits on the upper and lower center bar on the side fairing. The unique fin design is a real eye catcher and can be used alone or with Add On part 45-1629NUB chrome fairing air intake accents. Uses silicone and/or self adhesive tape to install. Fits the GL1800 01-10. Pair.



45-1629NUC Chrome Mesh Inserts Only \$59.95

Tri-chromed ABS inserts can be used alone or as replacement for Add On part 45-1629NUB, 01-10 Side Fairing Accents with Mesh Inserts. They come as a set of 4 pieces and are an easy way to have the look of a chrome radiator grill without the hassle of taking the bike apart. Installs with tape and/or silicone. Fits the GL1800 01-10. Pair.



45-1629LED Predator® Grills LED Light Kit \$22.95

Amber LED custom light kit was made to light up the air intake area with Add On parts 45-1269NUB and 45-1629NUD chrome fairing accents. Included are two strip lights with 3 LEDs each, measuring 2 inches long and 3/8 inch wide and installs with two-sided tape. The 36 inch lead wires can be wired into the running lights in the front mirrors or can be used on any part of a bike, trike or trailer. This is a special order part, when ordering other colors, minimum 30 day lead time. Universal fit. Pair.

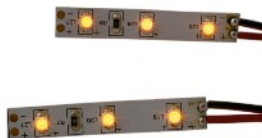

45-1629NUB Chrome Air Intake Grills with Mesh Inserts \$171.95

These tri-chromed ABS accents completely cover the side fairing air intake grill giving the bike a bigger, bolder look with chrome. Included are 4 chrome mesh inserts giving the look of chrome radiator grills so there is no need to take the bike apart. Applies with silicone and/or self-adhesive tape. The optional light kit adds even more impact reflecting off the chrome, Add On part 45-1629LED. Fits the GL1800 01-10. Pair.



45-1629NUD Chrome Air Intake Grills with Predator Grills \$191.95

Tri-chromed ABS accents completely cover the side fairing air intake grill giving the bike a bigger bolder chrome impact. This eye catching combination of the 4 piece chrome predator grills, Add On part 45-1629NUA, and Add On part 45-1629NUB, chrome side fairing accent, gives an additional option for covering the air intake grills. Applies with silicone and/or self-adhesive tape. Fits the GL1800 01-10. Pair.



45-1611NUA Amber LED Side Light Kit \$75.95

Beautiful side lights contain 18 amber LED lights covered with a clear lens and encased in a chrome housing. They mount above the valve covers adding extra lighting to the side of the bike. Can be used as a running and turn signal light. Fits the GL1800 01-10. Pair.



GL1800

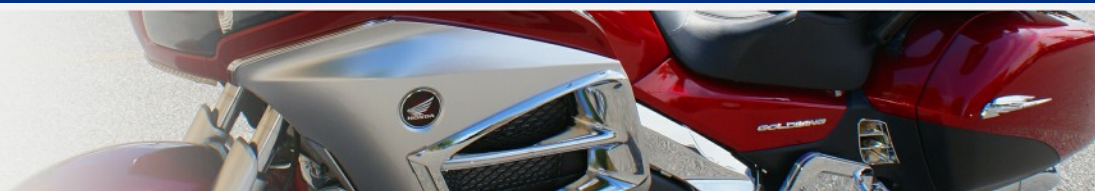

Adjustable Highway Boards and Pegs

These are die cast and chromed plated pegs and boards with chrome clamps and chrome mounting arms which attach to the case guards. The mounting arm has 7 possible positions for adjustment to meet the rider's comfort and will work on any 1 inch bar. Fold up feature moves them out of the way when not in use. Fits the GL1800 or bike with a 1 inch bar. Pair.

18548A Adjustable Highway Pegs \$218.95

18548C Adjustable Driver Boards \$319.95

18548D Adjustable Comfort Pegs with Heel Rest \$269.95



45-1620 Heel-Toe Shifter \$71.95

The tri-chromed bracket with shifter pegs mounts to the stock peg, for those who want the convenience of a heel toe shifter. Fits the GL1800. Single.

45-1620A Driver Board Set with Heel-Toe Shifter \$309.95

Tri-chromed heel/toe shifter with chrome driving boards add a sporty look to the bike as well as the comfort of the heel/toe shifter operation and a larger board for the feet. Easy to install. Fits the GL1800. Single.

Replacement Rubber Ring for Shifter Peg: Add On Part 38-11331-R \$2.95



45-1613 Adjustable Foot Peg Mounts \$169.95

These are beautiful universal chrome adjustable peg mounts and work on any 1 inch bar. They are adjustable to 7 positions to meet the rider's comfort needs. Includes mount, clamp and clevis. Used on Add On parts 18548A adjustable highway pegs, 18548C adjustable highway boards, 18548D adjustable highway peg with heel rest. Pair.

45-1612 Driver Boards \$189.95

Chrome driver boards have rubber inserts and provide a wider foot surface for a more comfortable ride. Boards are made of billet aluminum. These boards are universal in use and when used with the appropriate hardware, there are many combinations of highway board sets that can be made. Used for Add On parts 45-1620A driver boards set with heel toe shifter and 18548C adjustable highway boards. Fits the GL1800. Pair.

45-1607 Driver Foot Peg Brackets \$114.95

Tri-chromed brackets replace the dull gray brackets to add a nice chrome accent to the bike. Uses OEM hardware to install. This part is also used with Add On part 45-1620A driver board set with heel toe shifter. Fits the GL1800. Pair.



Rain Deflectors \$82.95

Made by V&P Ent. and made in the USA. Lexan rain deflectors snap onto the case guard to provide foot protection from the rain and road debris. Easy to install by just snapping onto the case guard. Pair.

1803



45-1256 Chrome Fairing Air Vent \$69.95

Dress up your bike with these beautiful tri-chrome ABS air vents that fit on the lower inside fairing. They replace the O.E.M. black vents on the bike and the adjustable louvers allow for air flow adjustments. Easy installation by just snapping in. Fit the GL1800 01-10. Pair.

1805



Part	Fitment
1803	GL1800 01-05
1805	GL1800 06 & up

GL1800

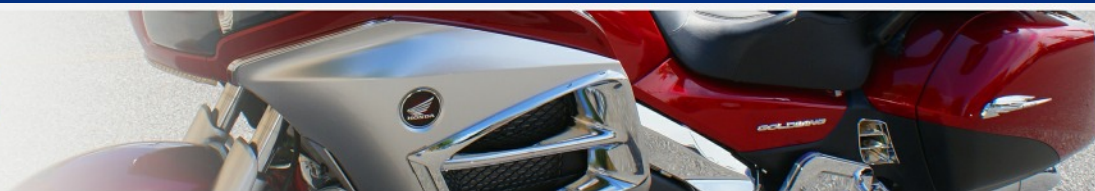

MC297-7 Driver Floorboards \$ 496.95

By MC Enterprises. Cast aluminum floorboards with heel-toe shifter provide convenient shifting and additional comfort for long rides. Mounts in original foot peg location. Includes all necessary mounting hardware. Fits the GL1800 01-06. Pair.



18393-545 Driver Floorboards \$419.95

Just what you want for a truly comfortable ride. These chrome driver floorboards include large boards to rest your feet, heel-toe shifter pegs to provide convenient shifting and an enlarged brake pedal. The brake side board includes a heel rest. Fits GL1800. Pair.



- 38-11331-R Replacement Rubber Ring for Shifter Peg part \$2.95**
- 45-1618-R Replacement Rubber Mats part \$25.95**

45-1604 Chrome Kickstand \$61.95

The beautiful chrome kickstand replaces the black OEM kickstand and has a larger foot for better support when the bike is on the side stand. Requires the OEM spring to install. Fits the GL1800. Single.



- Optional Add On Part 45-1636 Chrome Kickstand Spring \$9.95**

18393-545B Brake Pedal Only \$89.95

This chrome driver floorboard brake pedal with black rubber pad is larger for added comfort when in use. Drilling is required for a screw mount application. Used on Add On part 18393-545 GL1800 Driver Floorboards. Fits all Goldwing GL1800s. Single.



38-11331 Shifter Peg \$9.95

The universal chrome shifter peg has 3 black rubber inlays. Replacement peg for Add On parts 15393-545A1, Driver Floorboards, 18393-545, GL1800 Driver Floorboards and 45-1620 GL1800 Driver Boards. Single.



45-1636 Chrome Kickstand Spring \$9.95

The chrome replacement kickstand spring can be used on all GL1800 OEM kickstands and on Add On part 45-1604, chrome kickstand. Fits the GL1800. Single.



45-1616 Black Kickstand Extension \$14.95

This black kickstand extension is made of steel and is made to fit the OEM kickstand. No drilling is required and it mounts easily. Fits the GL1800. Single.



HST-2 Replacement Side Cover Studs \$36.95

Made in the U.S.A. These high quality replacement studs are perfect for Honda street and touring bikes. Two studs are provided with each stud measuring about 2 3/4 inches in length and 9/16 inch in diameter. They can easily be cut or filed down to obtain the length required for the repair work. Adhesive is included for mounting the studs onto the side covers. It is recommended that new grommets be purchased for a good hold if the original ones are in poor condition. Pair.

HST-2A Studs Only \$26.95 Pair.



8265-S J-B Weld Only \$7.95 Single.



45-6650-10 1/4 Inch Chrome Plugs \$5.95

The chrome ABS caps fill in the 1/4 inch or 6 mm Allen head screw opening. They provide a smooth chrome finish to give a polished look to the bike. Great for show bikes. 10 Pack.



GL1800

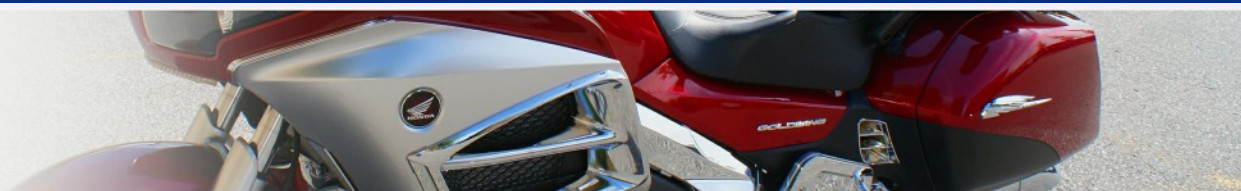

Saddlebag Scuff Cover Inserts

These tri-chromed ABS covers insert into the opening of the scuff cover. They look great used alone or with other chrome pieces for the bike. Easy to install by just snapping into place for a secure fit. Pair.

Part	Fitment	Price
45-1898	GL1800 2012 & up	\$61.95
45-1844	GL1800 2001-2010	\$59.95



45-1898



45-1844



45-1695 Chrome Engine Lower Side Covers \$179.95

These beautiful tri-chromed ABS covers are replacements for the OEM covers on the bike. They have a unique design to give them definition and style. Fits the GL1800 12 & up. Pair.



45-1632 Side Cover Accents \$44.95

These tri-chromed ABS accent pieces are made to fit around the "Gold Wing®" emblem. They are a great chrome addition to the side of the bike, being beautiful as well as practical. They can also help protect or cover the side from damages or scratches. Easy to install with self-adhesive tape. Fits the GL1800 01-10. Pair.



45-1804 Saddlebag Scuff Covers \$81.95

Tri-chromed ABS scuff covers replace the black OEM covers on the bike. They look great used alone or with other chrome pieces for the bike such as Add On part 45-1844 saddlebag scuff cover inserts. Easy to install. Fits the GL1800 01-10. Pair.



45-1804B Saddlebag Scuff Covers with Inserts \$131.95

This chrome ABS saddlebag scuff cover set combines both the chrome saddlebag inserts, Add On part 45-1844 and chrome saddlebag scuff covers, Add On part 45-1804 for price and convenience. The two work perfectly together and add a great chrome accent to the bike! Fits the GL800 01-10. Pair.



45-1617 One Piece Frame Covers \$125.95

This tri-chromed ABS piece replaces both the dull gray pivot and frame cover making one complete smooth chrome accent. Included are round rubber inserts, Add On part 45-1606-R, Fits the GL1800. Pair.

45-1606-R Rubber Inserts \$3.95

Round rubber inserts use self-adhesive tape to mount. Pair.



18541 Chrome Passenger Floorboard Risers \$69.95

These tri-chromed risers will raise the passenger boards 1 1/2 inches to provide the passenger with the ability to change the position of the board height for a more comfortable ride. Fits all Goldwing GL1800s. Pair.



GL1800

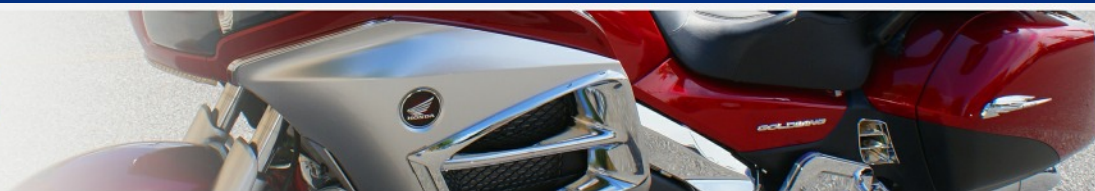

45-1601 Chrome Passenger Floorboard Under Plate \$38.95

These tri-chromed ABS underplates replace the dull gray bottoms on the passenger boards adding a great chrome accent when the boards are folded up. Add eagle emblems for a great show bike look. Easy to install. Fits the GL1800. Pair.



45-1603 Passenger Floorboard Step Covers \$61.95

Tri-chromed ABS step covers replace the dull gray covers behind the passenger floorboards. Create a complete chrome look for this area of the bike or cover up scuff marks. Fits the GL1800. Pair.

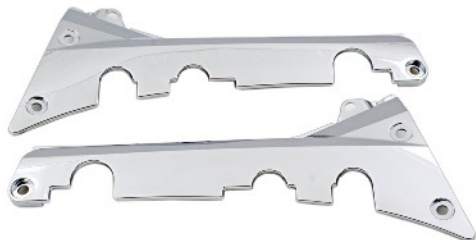

18SS2 Passenger Adjustable Foot Pegs \$156.95

The tri-chromed and rubber foot pegs provide a more comfortable ride for the passenger with a two position adjustment to rest the foot. They mount between the bike and board and when in the down position the peg sits behind the passenger's boards and out of the way. They will not work if passenger floorboard risers have been installed and will not work on bikes that have been converted to trikes. Fits the GL1800. Pair.



Accessory Switch Kits and Components

Accessory kits provide additional control of lighting and accessories on the bike. They are a convenient way to have control at your fingertips. Each kit consists of a combination of rocker switches, meter and chrome ABS plates. All kits include a wire harness and instructions. Drilling is required to install the units. Fits all GL1800s or on any flat surface.

18187 Economy Accessory Light Kit \$24.95

Includes: 4 lighted switches and wire harness.



18188 Digital Voltmeter and Accessory Switch Kit \$45.95

Includes: wire harness, lighted switches and LCD voltmeter to determine voltage used.



18189 Accessory Light Kit with Chrome Panel \$45.95

Includes: wire harness, lighted switches and chrome ABS plate. Plate measures 2 1/4 inches x 2 1/4 inches and mounts using self-adhesive tape.



18190 Digital Voltmeter, Accessory Switches and Chrome Plate Kit \$65.95

Includes: wire harness, lighted switches, LCD voltmeter and chrome ABS plate. Plate measures 2 1/4 inches x 2 1/4 inches and uses self-adhesive tape to mount.



Part	Component Description	Price
45-1215-1	Chrome plate - 4 cutouts for switches	\$19.95
45-1215-2	Chrome plate - 4 cutouts for switches & voltmeter	\$19.95
45-1405	Digital Voltmeter with LCD readout	\$29.95
673-187G	Green lighted rocker switch	\$4.95
673-187R	Red lighted rocker switch	\$2.95



18189



18190

GL1800

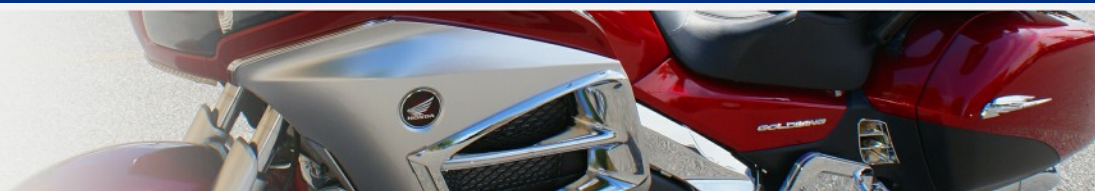

45-1243 NOVIBE® Comfort Grips \$99.95

Tri-chromed grips have the most comfortable cushioned rubber for a great ride. They look beautiful and the rubber rings go completely around the grips to provide a comfortable hold at all times. Easy to install, they work on any 7/8 inch grip with or without the damper and are 150 mm long. Comes with interchangeable grip ends and hardware to adapt to different bikes. Pair.



45-1206W Adjustable Clutch and Brake Levers \$62.95

Beautifully chromed wide clutch and brake levers are adjustable up to 7 different reach positions to meet the rider's hand span comfort for long enjoyable rides. Fits the GL1800. Pair.



45-1209 Chrome Damper \$32.95

This chrome damper replaces the black damper on the bike. It gives the bike an extra chrome accent which pairs up nicely with chrome grips for a classy look. Fits GL1800. Pair.



45-1237HGR Rist Rest® \$24.95

A beautiful universal throttle assist will give you more comfortable miles with its extra large 2 1/2 inch rest with rubber insert. Works with heated grips as well as non-heated grips. The Rist Rest® has elongated slots to make it adjustable to fit most 4 screw end cap grips on the GL1800. They come with longer screws and an Allen wrench for easy installation. Fits right side only. Single.



393-617R Rail Grips \$39.95

These die cast rail grips fit handlebars measuring 150 mm x 7/8 inch. Grips have soft rubber inserts with chrome overlay for a classic look. The fit all Goldwings. Pair.



Hand Warmers \$81.95

By V & P Inc. and made in the USA. These shields protect the rider's hands from wind, rain, and cold weather. They attach to the brake and clutch levers using existing hardware and are made of polycarbonate. Fits GL1500 and GL1800s. Pair.

Part	Color
1634	Bronze
1635	Clear



393-617RH Road Hawk Grips \$22.95

By Emgo. Classic grips with soft black foam and chrome end caps embossed with a chrome eagle emblem and the word "Roadhawk" in red. A great economical set of grips. Fits any 150 mm x 7/8 inch bar. Fits all Goldwings. Pair.



15678-021 Helmet Holder Studs \$15.95

This chrome helmet holder stud is a convenient holder for helmets or other items when making quick stops. The stud replaces the lever bolt on either side of the bike. Fits all GL1800s and GL1500s. Pair.

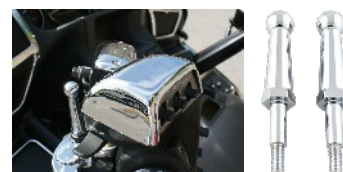

45-1253R Right Master Cylinder Cover with Switches \$47.95

A convenient accessory switch kit fits over the right master cylinder and puts accessories at your finger tips. Included are the chrome cover, 4 green light switches and a wiring harness which wires directly to the battery. Fits the GL1800. Single.



GL1800

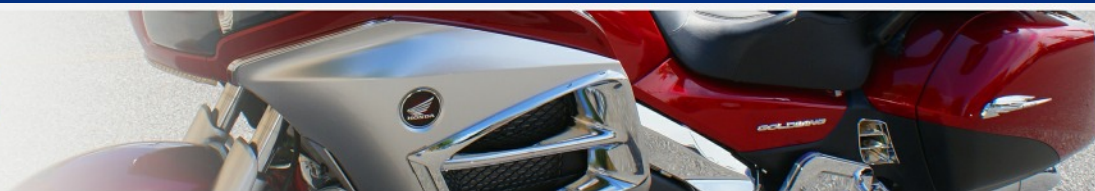

Master Cylinder Top Covers

Tri-chromed reservoir covers are beautiful and add a great touch of chrome to the dash area of the bike. The eagle designed cover is embossed with the words "free spirit" and all include chrome screws. Fits the GL1800 and GL1500.

Part	Description	Price
57-1097CG	Chrome with gold eagle - Single	\$29.95
57-1097C	Chrome with chrome eagle - single	\$15.95
15793-204P	Plain Chrome - Pair	\$27.95
57-1097CG-S	Chrome replacement screws parts 57-1097C, 57-1097CG and 793-204S Pair.	\$1.95

MK-D Driver Drink Holder \$19.95

The economical drink holder is designed to attach to the handlebar clamp screws with a chrome ABS mounting bracket. The drink holder swivels to prevent drinks from spilling and the holder folds-up when not in use. Holds a 12 ounce drink can with adjustable arms. Black. Fits the GL1500 and GL1800. Single.



Optional mount Add On part 15503D \$21.95.

670-839 Chrome Kill Switch Cover \$9.95

The tri-chromed kill switch cover goes over the cover on the bike adding a nice touch of chrome. It has an indicator line to identify positions. Mounts with self-adhesive tape. Fits the GL1500 and GL1800. Single.



4553-MN5 Handlebar Clamp Plugs \$8.95

The tri-chromed ABS plugs cover the screw holes and add a nice touch of chrome to the handlebars. Easy to install by just snapping in. Fits the GL1500 and GL1800. Pair.



M60-6611 Adjustable Rear View Mirror \$12.95

This large rear view mirror optimizes your viewing for a safer ride. The mirror is on a swivel to angle as needed. Easy to install with a universal mount or can be permanently attached to the bike's rear view mirror. Available in flat black only. Single.



V599 Blind Spot Mirror \$3.95

The universal small rear view mirror measures 2 1/8 inches x 1 1/2 inches x 3/4 inches and attaches directly to the bike mirrors using self-adhesive tape. It angles to provide additional viewing towards the rear of the bike. Single.



GL18BR Under Mirror Mount Brackets \$54.95

By SoCal Motogear. Uses existing mount and made of 10 gauge heavy duty steel powder coated brackets. Lets you mount virtually any type of lighting underneath front indicator mirrors. Fits GL1800 and F6B. Pair.



45-1846 GPS/Radar Mounting Kit \$49.95

The tri-chromed universal mount holds many types of electronic devices, putting them in easy reach for hands on use. The adjustable mount can be angled to meet any position needed. The mount attaches to the handlebar clamp screws on all Gold Wings, Valkyries and VTX bikes. The extra hole allows for attaching other items like a cup holder. Universal fit. Single.



45-1230 Chrome CB Controller Accent \$26.95

This accent is made of tri-chromed steel and fits over the CB controller on the left side of the bike. Uses self-adhesive tape to mount. A nice chrome accent for the dash area of the bike. Fits the GL1800. Single.



GL1800

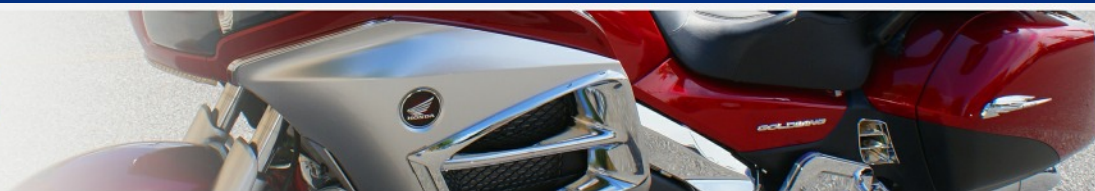

Pathfinder Sequential LED Turn Signals with Daytime Running Lights \$269.95

NEW By SocalMotogear. Dynamic LED front directional lights are white daytime running and when the turn signal is activated the light changes to a sequential amber light. A eye catching light that will draw attention to the bike. Fits GL1800s. Pair.



Part	Color
G18DTC	Clear Lens
G18DTS	Smoke Lens



45-1232 Chrome Mirror Housings \$85.95

Beautiful chrome mirror housings replace the stock housings on the bike. They create a fantastic chrome accent to the front of the bike or can be an economical replacement for weather worn or damaged housings. They also look great along with other chrome accents for the front of the bike. Fits the GL1800. Pair.



Optional: Add On part **45-1212-G**, Mirror Grills

45-1217 Front Mirror Trim \$23.95

This tri-chromed front mirror trim fits the outer edges of the rear view mirror adding a nice contrast with the painted mirrors. Easy to install with self-adhesive tape. Fits the GL1800. Pair.



20-67A1A LED Amber Pyramid Side Light \$29.95

The lights are encased in a chrome housing with a clear lens containing 6 super bright amber LEDs each. They have a universal fit to work on any flat surface. Ideal for any bike, trike or trailer. They mount with self adhesive tape, measure 4 x 1 1/4 inches and have a 36 inch lead wire. Functions as running or turn signal lights. Pair.



7443A Pathfinder High Performance LED Amber Replacement Bulb \$20.00

Rear/front signal light upgrade is a direct 7443 bulb replacement. Plug and play. Single.



45-1212-G Chrome Mirror Back Accents \$25.95

Tri-chromed ABS grills have a bar design to match perfectly with the 2001-2005 trunk and saddlebag grills, Add On parts 45-1811-G trunk and 45-1812-G saddlebag. Easy to install with self-adhesive tape. Fits the GL1800. Pair.



LED Arrow Lights \$14.95

These 9 amber LED lights have a 2 wire function for brake, running or turn signal. Flashes automatically when wired into the turn signal. Measures 2 1/4 inches x 1 1/2 inches, is encased in a clear housing and mounts to any flat surface with self adhesive tape. Pair.



Part	Color
20-64A8A	Amber
20-64A8R	Red

Pathfinder Adapter/Harness for 2001-2005 GL1800/F6B

Part	Fitment	Price
0105A	2001-2005 GL1800	\$18.00
F6B1A	2001-2005 F6B	\$21.95



0105A

F6B1A

L18SWB Switchback LED Bulb \$27.50

Runs white then amber when directions are activated. 7443 application. Requires Part **GL88NC LED Flasher \$29.00**. Single.



01-P7443 Front Directional Bulb \$2.31

Clear 12V 21/5W standard replacement front directional bulb. Fits the GL1800. Single.



Euro Front Directional Lights \$66.95

The front directional light is Euro styled with a no line smoke lens and has amber 21/55 watt bulbs. These are direct replacements for the stock lights. The light includes foam gaskets for a tight fit. Fits the GL1800 and F6B. Pair. Replacement bulb, Part **AD-2011GY \$4.95**

Part	Color
45-1228S	Smoke
45-1228	Clear
AD-2011GY	Amber Bulb



GL1800

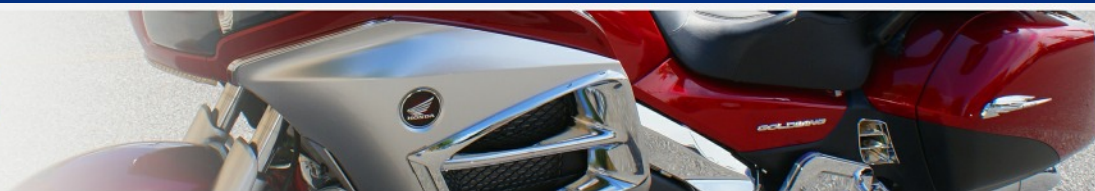

45-1297 Fairing Side Trims \$55.95

Tri-chromed ABS accents go over the black OEM areas on the front inside fairing panels and along the strip next to the radio and dash pouches following the curves of the bike. Installation is easy using double sided tape. Designed to fit with Add On part 45-1296 GL1800 12-14 Dash Door Accents. Fits the Goldwing GL1800 12 & up. Pair.



45-1257 GL1800 Air Filter Intake Screens \$29.95

NEW Grated mesh to prevent creatures from nesting in the bike's air intake. Easily snaps on top of the air filter intake. Has 5mm holes for airflow. Fits all GL1800s. Pair.



Chrome Fuel Door Accent \$24.95

Chrome Fuel Door Accent trims the outside edges to provide beauty and protection to the fuel door. Uses self-adhesive tape to mount. Single.



Part	Fitment
45-1498	GL1800 12 & up, 06-10 airbag
45-1402	GL1800 01-10

Chrome Radio Knobs

Chrome ABS radio knobs are a complete replacement for the OEM black knobs on the bike. Adds a nice touch of chrome especially to the newer years with the embossed eagle. Pair.

Part	Fitment	Price
45-1499	2012 & up w/eagle	\$13.95
45-1403	2001-2010	\$11.95

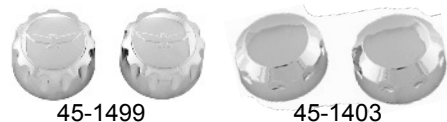

Dash Door Accents \$65.95

These chrome ABS dash door accents add a great look to the bike making the dash doors really stand out. The set includes a right and left chrome trim which outlines the dash doors and a chrome accent to cover the latch on the clutch side door of the bike. They are easy to install using the silicone which is included. Fits the GL1800. Pair.



45-1254 Fits 01-10

45-1254-LB
all years
\$4.95

45-1296 Fits 12 & up



Chrome Key Insert \$17.95

Chromed ABS key inserts replace the OEM black inserts on the bike. Comes with an optional black key pad to help protect the chrome from scratching. Fits GL1800 01-05. Single. May not work with all European bikes.

Part	Fitment
45-1404	2001-2005
45-1404NU	2006 & up
45-1404D	Replacement Pad - all years \$1.95



45-1404

45-1404NU & 45-1404D

Remote Cover \$7.95

This remote cover is an economical way to protect the remote and key area on your dash from getting scratched or otherwise damaged when the bike is in motion or parked. The cover fits perfectly over the remote with cutouts for access to the control buttons. Made of a soft black rubber material to feel comfortable in your hand and provide protection. Single.

Part	Fitment
45-1699B	2012 & up
45-1630B	2001-2010

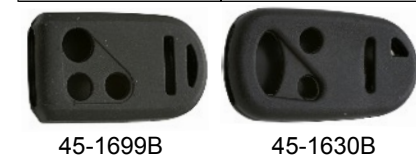

45-1699B

45-1630B

GL1800

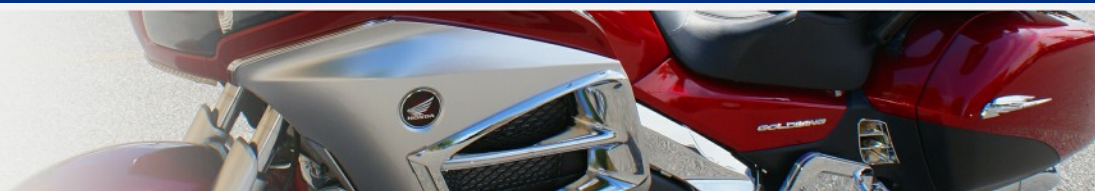

Front Speaker Grills \$41.95

These tri-chromed ABS grills are perfectly contoured to fit the outline of the front speakers and have a single bar across the center. Included are two modern eagle emblems, Add On part 091-6211A4G, to place on the bar's center circle, or use any emblem or sticker you may desire. Easy to install with self-adhesive tape. Pair.



091-6211A4G

Part	Fitment
45-1234	2001-2005
45-1235	2006 & up
091-6211A4G	Gold Eagle 3/4" x 1/4" \$3.95



45-1234



45-1235

45-1224 Radio Accent Panel \$39.95

This tri-chromed plated steel accent with cutouts fits over the radio control panel adding a nice touch of chrome. Easy to install with self adhesive tape. Fits the GL1800 01-10. Single.



132-1800 Cigarette Lighter/Accessory Socket \$15.95

The chrome cigarette lighter plugs into the existing wire harness on the GL1800 and includes a 10 amp fuse. Can be used as an extra accessory socket for your electronic devices. For older bikes, this unit can be wired directly into the bike. Drilling is required. Single.



45-1401 Chrome Instrument Panel \$42.95

This tri-chromed ABS accent outlines the instrument panel in chrome and adds protection and beauty to the front dash. Fits the GL1800 01-05. Single.



45-1854 LED Passenger Armrest Light w/Running, Brake & Sequential Turn Signals \$269.95

NEW Tri-chromed stylish ABS LED light is a running, brake and sequential turn signal light all in one. Wraps around the armrests. Fits the GL1800 06 & up. Pair.



678-034B Black Beaded Seat Cover \$29.95

The rounded wood beaded seat cover gives the rider comfort by allowing air to circulate between the user and the seat. Cooler in hot weather and dryer in the rain. Easy on and off with a bungee cord system. Measures 11 inches x 16 inches. Fits the GL1800 and GL1500 driver seats and accommodates others this size. Single.

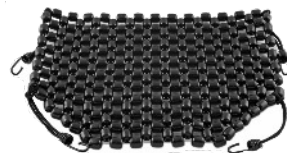

18673-817K Driver Side Mount Backrest \$203.95

The side mount style backrest makes for a more comfortable ride for the driver. The pad is made of the same fabric as the OEM material and comes with a permanently attached storage pouch. The pouch is made of the same material as OEM. The backrest is adjustable forward and back, has a fold down pad that mounts to a chrome loop and mounting hardware which attaches to the passenger grab rails. Fits all GL1800. Single.



18673-816K Driver Insert Mount Backrest \$199.95

This black insert mount style backrest is made of the same fabric as OEM. The backrest pad is adjustable vertically to meet the driver's comfort. The pad folds down to allow easy on and off access to the passenger seat. A storage pouch is permanently attached to the pad and has a Velcro closure. Installation requires cutting a slit through the driver's backrest. Works on heated and non-heated seats. Fits all GL1800. Single.



45-1706-K Chrome Adjustment Knob for Backrest \$17.95

45-1706R Nylon Compression Ring \$3.95

Replacement parts fits the Add On side mount backrests for GL1800, GL1500 and GL1200. Single.

45-1706-K



45-1706R



GL1800

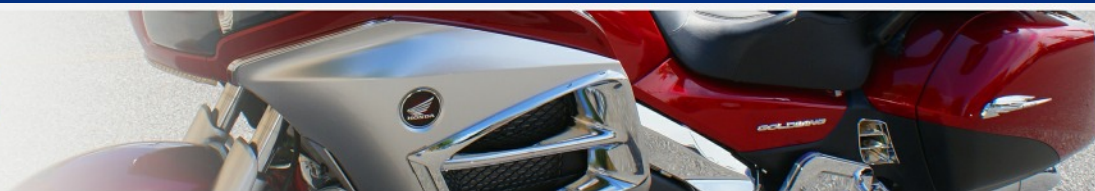

Rear Speaker Grills \$41.95

These tri-chromed ABS grills are flat and contoured to fit the outline of the rear speakers with a single bar across the middle. Includes two modern eagle emblems to place on the bar's center circle, or use any emblem or sticker you may desire. Easy to install with self-adhesive tape. Pair.

Part	Fitment
45-1834	2001-2005
45-1835	2006 & up
091-6211A4G	Gold Eagle 3/4" x 1/4" \$3.95



091-6211A4G



45-1834



45-1835

45-1847 Rear Pouch Door Accents \$12.95

Tri-chromed accents add a finishing touch on the rear door pouches and the contrast of chrome on black makes them stand out. Easy to install, they fit over the rear door latch with self-adhesive tape. Measures 1 inch x 2 inch. Fits the GL1800. Pair.



45-1842 LED Brake Turn signal Spoiler Light \$87.95

A multi-functional light consisting of 2 rows of 40 super bright amber and red LED lights, works as a running, brake and turn signal light all in one. A great attention getting light that brings awareness as vehicles approach the bike especially at stops. The light measures 13 inches long and only fits into the OEM spoilers. Fits GL1800 01-10. Single.



MK-P Passenger Mugger \$19.95

An economical drink holder designed to attach underneath the armrest with a chrome ABS mounting bracket. The drink holder swivels to prevent drinks from spilling and the holder folds-up when not in use. Holds a 12 ounce drink can with adjustable arms. Black. Fits the GL1100, GL1200, GL1500 and GL1800. Single.



45-6965B Rain Seat Cover \$46.95

The black seat cover has an elastic edge to fit snugly over the OEM driver seat, passenger seat and passenger backrest. It is made of polyester, is UV and water repellent and is colorfast grade 4. The compact size makes it perfect for traveling and includes a carrying case. Works with or without the side mount driver backrests. This black rain seat cover measures 21 inches x 12 inches x 12 inches. Fits the GL1800s. Single.



18673-818K Passenger Armrest \$203.95

The armrests provide a more comfortable ride for the passenger. The swing out feature allows easy access on and off the bike. Comes with chrome mounting brackets, black pads and hardware to mount. The pads are made of the same type of fabric as the OEM pads and measure 10 inches x 5 inches x 3 inches. The armrest arms mount to the antenna base and require two antennas to mount to protect the trunk. Fits the GL1800. Pair.



Armrest Light Kit A great way to add extra lights and visibility to the side of the bike. The kit mounts to the armrest mounting plate with self-adhesive tape and is finished off with a star washer to add a decorative touch. Fits the GL1800 and GL1500 bikes with armrests. Pair.



Part	Color
104-A	Amber \$59.95
104-B	Blue \$59.95
104-F	Multi Flashing \$61.95
104-W	White \$59.95

GL1800

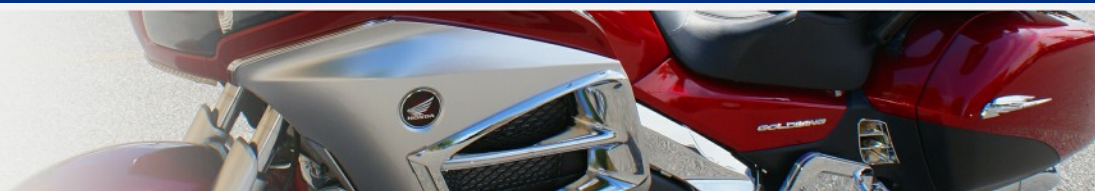

18673-629 CB Antenna \$109.95

This CB radio antenna attaches to the trunk in the same manner as the OEM radio antenna. It has a spring loaded fold down feature, was designed not to wobble, has an angle adjustment stop and includes a ground strap and mounting hardware. Fits the GL1800. Single.

Part	#	Description - Each item sold single for the CB Antenna	Price
18673-629AA	1	Replacement Antenna Tip	\$5.95
45-1810-A/D	2	Replacement Staff and Tip	\$48.95
45-1810B	3	Chrome Tube Top Accent fits only 18673-629	\$9.95
45-1810-P	4	Replacement Swivel Pin	\$5.95
45-1810-S	5	Replacement Set Screw	\$3.95

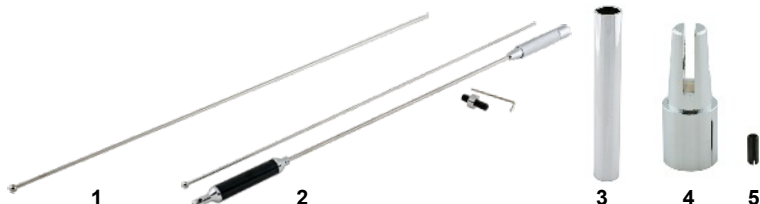

45-1810EU FM/Satellite Antenna \$34.95

The radio antenna helps to eliminate FM interference when traveling through high FM output areas. It has a fold down feature to help when stowing the bike. Measures 16 inches. Single.



18678-824 Rear Speaker Kit \$65.95

The rear speaker kit is a plug and play unit providing 35 watts of power into the bike's standard audio system. Includes two 5 inch speakers and wiring harness. Fits the GL1800 01-05. Single.



Angel Eyes LED Speaker Lights \$29.95

The speaker light contains 2 LED lights encased in a clear durable plastic light ring which give off a gentle halo glow and are visible in daylight while not being overpowering in darkness. The rings measure 4 inches in diameter, are 1/4 inch thick and sit on top of the rear speakers. There is no interference with the speaker operation. This unique lighting adds additional visibility to the bike and looks great. Included is an optional 5 inch gasket to use on a 5 inch speaker. Fits the GL1800 01-06 rear speakers. Pair.

Part	Color
45-1849A	Amber
45-1849L	Blue
45-1849R	Red
45-1849W	White



45-1838 Trunk Rack \$109.95

This tri-chromed rack is a custom design which follows the curves of the trunk and will fit with a lighted spoiler. It has a tubular bar design and includes 2 tabs with holes for mounting flag poles or holding items onto the trunks rack with bungee cords. Mounting hardware included. Measures 12 inches x 22 inches. Fits the GL1800. Single.



45-1801-2/3 Speaker Wire Harness \$27.95



501-113A Trunk Rack Pads \$13.95

The set consists of 4 chrome star washers and 4 black rubber washers and is ideal for mounting trunk racks or rails onto the bike. Each measures 1 1/2 inch in diameter. 4 Pack.



GL1800

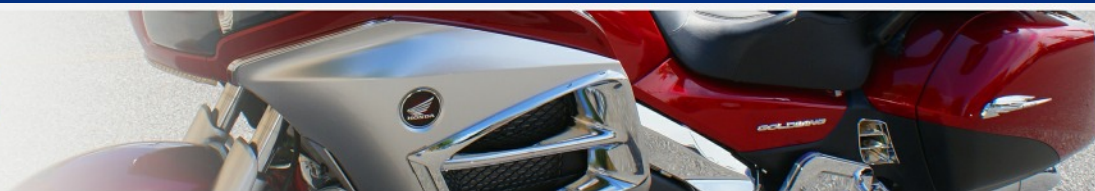

45-1814-G Trunk Brake Light Grills \$49.95

These tri-chromed ABS Euro-style trunk grills outline the trunk break light with a single bar of chrome. They add a great look to the bike and maximize light visibility. Uses self-adhesive 3M tape to mount. Matches with Add On part 45-1815-G 06-10 saddlebag grills. Fits the GL1800 06-10.



45-1815-G Saddlebag Brake Light Grills \$49.95

Tri-chromed ABS Euro-style grills trim the saddlebag light outlining the whole light with a single bar of chrome and have one center bar. They add a great touch of chrome to the bike. Easy to install by using self-adhesive 3M tape to attach. Matches Add On part 45-1814-G 01-10 trunk grills. Fits the GL1800 06-10. Pair.



45-1821 Trunk Lock Escutcheon \$14.95

This simple triangle design black accent will help protect the key lock area on the trunk from being scratched by the key. Included is an optional highly reflective insert to change the black area into a reflective one to add more visibility to the rear of the bike, even during daylight hours. Fits the GL1800. Single.



45-1803 Chrome Trunk Molding \$49.95

Tri-chrome ABS pieces replace the painted OEM molding along the trunk adding a nice touch of chrome to the bike. Matches with Add On part 45-1802, chrome saddlebag moldings. Fits the GL1800 01-10. 3 piece set.



45-1811-GE Trunk Brake Light Grills \$51.95

These tri-chromed ABS trunk grills outline the trunk brake light with a single curved bar. Easy to install with self-adhesive tape. Matches with Add On parts 45-1815-G 06-10 and 45-1812-GE 01-05 saddlebag grills. Fits the GL1800 01-05 and 12 & up. Pair.



45-1812-GE Saddlebag Brake Light Grills \$51.95

Tri-chromed ABS saddlebag grills have a Euro design and easily mount with self-adhesive tape. Match perfectly with Add On parts 45-1814-G 06-10 and 45-1811-G 01-05, 12 & up trunk grills. Fits the GL1800 01-05. Pair.



45-1822 LED Lighted Trunk Handle \$49.95

The tri-chromed ABS trunk handle comes with LED lights to add additional visibility to the rear of the bike. Contains 8 red LED lights encased in a chrome handle. The light works as a running or brake light and requires drilling to install. Measures 9 1/2 inches. Fits the GL1800. Single.



45-1837 Chrome Eagle Trims \$51.95

Chrome ABS eagle emblem is an attractive accent which has an eagle head and wing design measuring 10 inches in length with an "1800" engraved in black on the side. The eagle is made with a slight curve allowing it to fit into a variety of places on bikes, trikes or trailers. Easy to install with self-adhesive tape. Great on trunk and saddlebags. Measure 10 inches long. Pair.



45-1811-G Trunk Brake Light Grills \$51.95

These tri-chromed ABS trunk grills have a 4 bar design. Easy to install with self-adhesive tape. Matches with Add On part 45-1812-G for 01-05 saddlebag grills. Fits the GL1800 01-05 and 12 & up. Pair.



45-1812-G Saddlebag Brake Light Grills \$51.95

Tri-chromed ABS saddlebag grills have a 5 bar design and easily mount with self-adhesive tape. Matches up with Add On part 45-1811-G 01-05 trunk grills. Fits the GL1800 01-05. Pair.



15993-197A Trunk Lid Handle \$25.95

Tri-chromed tubular designed handle makes it easy to access the trunk. Measures 7 1/2 inches and mounts on flat surfaces. Fits GL1800, GL1500 and many other bikes, trike or trailer trunks. Single.



45-1839 Chrome Eagle Trims \$43.95

Chrome ABS eagle emblem is an attractive accent which has an eagle head and wing design measuring 7 inches in length. The eagle is made with a slight curve allowing it to fit into a variety of places on many bikes, trikes or trailers. Easy to install with self-adhesive tape. Great on trunk and saddlebags. Measure 7 inches long. Pair.



GL1800

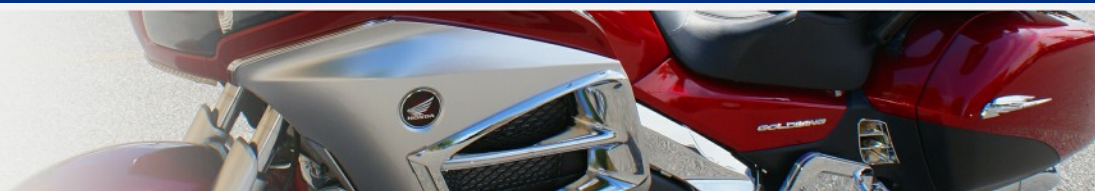

45-1240RLED Red LED Lighted Eagle Emblem \$69.95

This unique modern looking eagle has 14 super bright red LED lights and works as a running and turn signal light. The light uses self-adhesive tape. The eagle has a slight curve to fit on the windshield panel or trunk. Measures 7" x 2". Single.



18303-283 Chrome Exhaust Extensions \$149.95

Tri-chromed steel slash cut exhaust extensions blend into the contours of the bike's original pipes. Uses the original bolts to mount. Fits the GL1800. Pair.



45-1802 Saddlebag Chrome Molding \$62.95

Tri-chromed ABS moldings replace the painted OEM moldings on the bike adding a nice chrome accent to the saddlebags. Matches with Add On part 45-1803, chrome trunk moldings. Fits the GL1800 01-10. 4 piece set.



01-P7440 Rear Directional Bulb \$2.31

Standard replacement 12V 21W for OEM directional or tail light. Single.



V391C Interior Light \$14.95

This small interior light is perfect for the trunks of most bikes. Easy to install and wires in so you will always have light. The polycarbonate 12V interior light comes with a nylon switch for easy on and off operation. It has a metal base surface and mounts with screws on a 3 1/2 inch center. Separate ground and lead wires are supplied for electrical connection. Measures 1 3/4 inches x 3 1/2 inches x 4 9/16 inches. Single.



020-1804 Trunk Lid Pouch \$24.95

This black trunk lid pouch fits into the trunk lid and allows for more trunk storage and quick to reach items. Our slim line design allows more room up into the lid for items like helmets. Velcro closures are on all pockets. We have included reflective tape for added safety when stopped on the side of a road. Mounts into existing hardware. Fits the GL1800.



45-1812 Clear Saddlebag Lights \$104.95

Euro design replacement saddlebag lights come with an outer clear lens and inner amber and red lenses encased in chrome. Uses stock bulbs. Fits the GL1800 01-05. Pair.



Replacement LED Bulbs

Replacement trunk light has 13 bright LEDs mounted in a 360° clear housing. Fits all GL1800. Single.

Part	Light color	Price
AS-35DRLED	Red	\$16.95
AS-36DWLED	White	\$18.95



AS-35DRLED



AS-36DWLED

7443R Pathfinder High Performance LED Red Replacement Bulb \$20.00

Rear, saddlebag, brake light upgrade, direct replacement, plug and play. Fit the GL1800 and F6B. Single.



LP9T10 Universal/License Plate LED Bulb \$5.95

A replacement for the standard license plate bulbs & map dome lights in vehicles. Direct replacement, plug and play. Single.



Helmet Lock Extensions Tri-chromed helmet lock extension come in 4 designs. They slip through the helmet D-ring to make it easier to attach the helmet to the helmet holder latch under the trunk. Measures 3 1/2 - 4 inches long x 1 1/2 - 2 1/2 inches at the base.

Part	Description	Price
77-6021	Bike - single	\$8.95
77-6022	Trailer - single	\$8.95
993-135	Universal - pair	\$10.95
993-136	Nolan Helmets - pair	\$14.95



77-6021



993-135



77-6022



993-136

GL1800

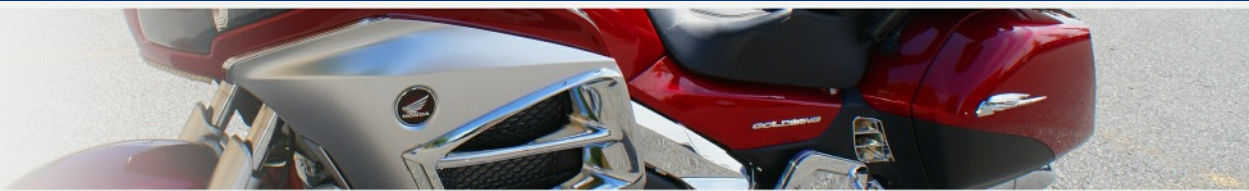

45-1897 Tail Light and Turnsignal Grills \$94.95

Beautiful chrome ABS grills outline the center tail and each rear turn signal light. They conform to the curves of each light making it easy to attach with self adhesive tape. The grills are rounded and have a smooth chrome finish. They match up with the Add On part 45-1811-G 01-05 and 12 & up Euro style grills to make a complete look. Fits the GL1800 2012 & up. 3 piece set.



020-1800 Luggage Liner Set \$90.95

Made of black 400 Denier nylon with zipper and flap closures, with pockets and handles. Trunk bag measures 13 1/4" x 22" and saddlebag 13 1/4" x 21". Fits all GL1800s. 3 piece set.



45-1899 Top Rear Fender Accent \$32.95

Made of tri-chromed ABS, the accent covers the large black area on the license hood cover. It has a sleek finish with a raised decorative ridge and provides a great touch of chrome. Uses double sided tape. Fits the GL1800 12 & up. Single.



28-6017LED LED Chrome License Frame \$84.95

Chromed steel license frame with 21 red LEDs functions as a running and brake light for added visibility. Two white LEDs on the inside of the frame shine onto the license plate. It comes with interchangeable red and clear lenses. Measures 7 3/16 inches x 4 1/4 inches inside the frame, includes chrome hardware to mount and has an 18 inch lead wire. Measures 7 1/8 inches x 5 inches on the outside edges. Single.



45-1836 Chrome LED Lighted Filler Plate \$99.95

This tri-chromed ABS piece fills the entire license plate area with chrome. There are 14 red LED lights along the bottom of the piece which can be used as a running and brake light adding more visibility to the rear of the bike. Easy to install with self-adhesive tape and comes with a 36 inch lead wire. Fits the GL1800 01-10. Single.



020-1805 Carpet Set \$46.95

GL1800 Carpet Set is black with black stitching. The set consists of 3 pieces, one to fit the bottom of the trunk with a detachable flap for access to the CD player and one to fit the bottom of each saddlebag. These are beautifully made and are easy to take out and clean. They fit perfectly for all GL1800s. 3 piece set.



45-1813 Chrome Rear Fender Trim \$31.95

Tri-chromed ABS rear fender trim adds a great touch of chrome to the bottom of the fender and hides any nicks and scratches from road debris. Easy to install with self-adhesive tape. Fits the GL1800 01-10. Single.



45-1895 Chrome Rear Fender Light \$99.95

Tri-chromed ABS fender light is a beautiful chrome accent for the rear fender. It has 12 bright red LED lights along the upper edge and works as a running and brake light. Easy to install with two screws. Fits GL1800 12 & up. Single.



45-1227R Red LED Rear Reflector Light \$21.95

This red LED reflector light has 15 bright lights encased in a chrome housing. Measures 1 1/4 inch x 3 1/2 inch. Single wire function as running or brake light. Sold single.



45-1100 Grills Chrome Grills. Pair. \$14.95

GL1800

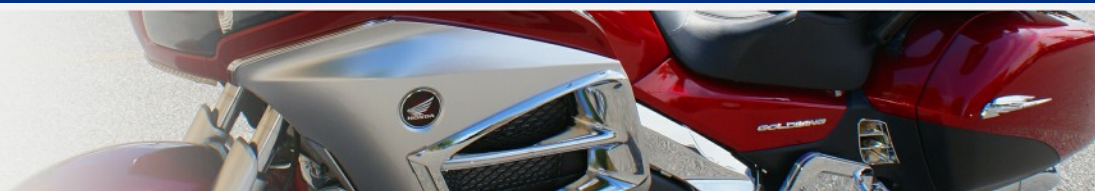

45-1806A Receiver Trailer Hitch \$244.95

This receiver trailer hitch is fairly easy to install and allows the rear wheel section to be removed in one piece. The hitch is invisible when receiver and ball are removed. The trailer hitch includes an H bracket, 2 arms, chrome 1 ¼ inch receiver with a 10 inch tongue, clip and pin and 1 ¾ inch chrome ball. Fits the GL1800 12 & up except airbag models. Single.



45-1806 Receiver Trailer Hitch \$244.95

This receiver trailer hitch is fairly easy to install and allows the rear wheel section to be removed in one piece. The hitch is invisible when receiver and ball are removed. The trailer hitch includes an H bracket, 2 arms, chrome 1 ¼ inch receiver with a 6 ¾ inch chrome tongue, clip and pin to attach the receiver and a 1 ¾ inch chrome ball. Fits the GL1800 01-10, except airbag models. Single.



45-1806-A Replacement Chrome Receiver, Pin and Clip \$41.95

Replacement receiver saves you money from replacing the entire trailer hitch. Includes 1 inch chrome receiver, pin and clip. Works on the 01-10 model bike, Add On part 45-1806.



45-1806-C Replacement Chrome Receiver, Pin and Clip \$54.95

Replacement receiver saves you money from replacing the entire trailer hitch. Includes 1 inch chrome receiver, pin and clip. Works on the 12 & up model bike, Add On part 45-1806A.



993-181A Chrome Trailer Ball \$22.95

Replacement trailer ball measures 1 7/8 inches. Single.



673-181 Chrome Trailer Ball Cover \$11.95

Tri-chromed trailer ball cover fits over a 1 ½ to 2 inch trailer ball and includes a foam insert to hold the cover in place. The cover helps to prevent the ball from rusting or helping to keep you and everything else clean when the ball gets greasy. Single.



090-143T Non-ABS Brakes Trailer Wire Harness \$18.95

This economical trailer wire harness allows the current from the trailer lights to be drawn directly from the bike battery using stock lighting circuits. Fits the GL1800 01-10 with Non-ABS brakes. Single.



45-1848 Trailer Wire Harness Converter \$18.95

The wire harness converter allows the connection of 5 wires from the bike to a trailer with a 4 wire system. The converter includes a circuit protector with fuse. Works on any system with a wire harness from the bike. Easy to install. Single.



45-1896 Isolated Trailer Wire Harness \$54.95

An all inclusive isolated trailer wire harness is a plug and play unit. Connects the 5 wire system between the bike and trailer. Harness has 4 isolation relays powered directly from the bike battery through a heavy duty wire and isolation fuse to protect the electrical system. Fits the GL1800 12 & up. Single.



45-1819 ABS Brakes Trailer Wire Harness \$39.95

The trailer wire harness allows the current from the trailer lights to be drawn directly from the battery using stock lighting circuits to the trailer. It is a plug and play unit and works on ABS or non-ABS brakes. Isolator is included to protect the computer board. Fits the GL1800 01-10. Single.



GL1800

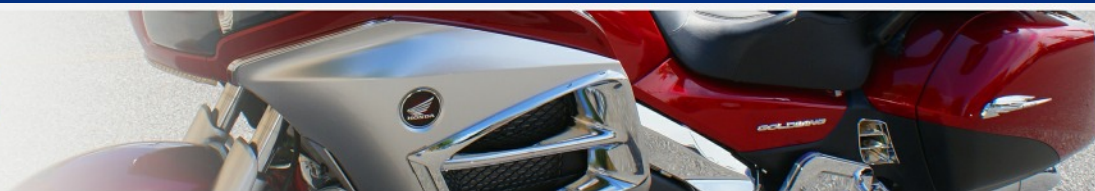

Receiver Hitch Cooler Rack \$153.95

This aluminum cooler rack is well engineered to carry heavy loads and is constructed of light weight durable aluminum that will not rust. This rack can be used with a vertical receiver with a 1 ¼ inch opening. The rack has a natural or black finish, measures 11 inches by 16 inches with a solid 1 inch framed edge with holes to attach bungee cords and a grate floor. Fits GL1800 with vertical receiver trailer hitch or any other vertical receiver with a 1 ¼ inch opening. Made in the U.S.A. Single.

Part	Color	Fitment
678-036	Natural	45-1806
678-036B	Black	45-1806
678-039	Natural	45-1806A
678-039B	Black	45-1806A



678-036



678-039B

Adjustable Receiver Cooler Rack \$169.95

For all those with trikes or who have a horizontal receiver hitch with a 1 ¼ inch opening, this lightweight, 3.15 pound, aluminum adjustable cooler rack can be adapted to meet your needs. It is capable of adjusting from 4 ¼ inches to 8 ¼ inches horizontally. Engineered with a reinforced double bar for stability and to hold heavy loads. It works on most trike conversion kits requiring a longer tongue to reach the trailer hitch receiver. The rack comes with a natural or painted finish, measures 11 inches by 16 inches with a solid 1 inch framed edge with holes to attach bungee cords and a grate floor. Adjustments can be made in less than two minutes by removing and reinstalling four stainless steel screws. Made in U.S.A. Single.

Part	Color
678-032	Natural
678-032B	Black



678-032



678-032B

77-0039 Trike Fender Rack \$65.95

Tri-chromed luggage rack mounts to the top of the fender of most trike kits with a flatter fender area. Adds additional storage for hauling bags. Includes hardware for mounting. The rails will adjust to even out while tightening the individual rails. Measures 8 inches x 11 inches. Single.



673-815 Trunk Rack \$99.95

This universal tri-chromed rail rack measures 22 inches L x 12 inches D x 2 ½ inch H. Fits many bikes and works well with trikes with no trunk. Single.



45-8946 Chrome Nerf Bumper \$199.95

The chrome nerf bumper adds both protection and a classic look to the back of the Motor Trike® Spyder 2 Plus 2 and any trike with a flat mounting surface. This bumper is constructed of 1 ½ inch steel tubing with capped ends. It is fully polished and chrome plated. Functionally, the bar bolts directly to the trike's frame. Measurements from end cap to end cap is about 38 ¼ inches and the horizontal measurement before the curve at each end is about 27 inches. Single.



670-013B Large Lid Handle \$50.95

Tri-chromed tubular design trunk handle has a wide comfort foam grip, most useful in very hot or cold weather conditions. Measures 17 inches in length. Fits GL1800, GL1500, GL1200 and trunks allowing for this size. Single.



20-64A6R-30 Red LED Flexible Strip Light \$26.95

This Red LED strip light is versatile and extremely flexible allowing it to be used in many places on a bike, trike or trailer. Add On used this to light underneath the 2005 GL1800 trunk. It contains 30 LEDs in a clear housing, measures 12 inches in length and has a 40 inch lead wire. The lights can be connected together to obtain any length desired. They mount with self-adhesive tape and have a two-wire function to work as a running, brake or turn signal light. Single.



GL1800

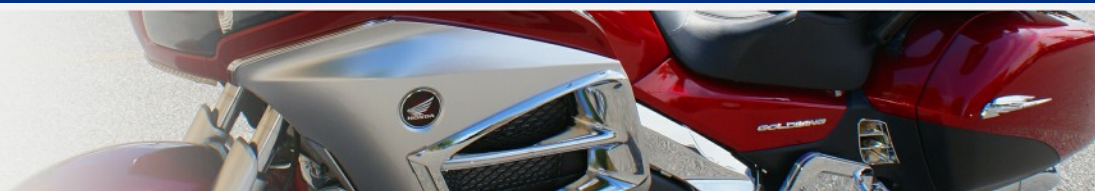

18741-180 Mud Flap with LED Reflector Light \$89.95
3741-180 Trike Mud Flap with LED Reflector Light \$89.95

This mud flap is made of sturdy rubber that can take a beating. Comes with a rectangular red LED reflector light encased in a chrome housing and the hardware to mount. Mud flap measures 10 inches x 7 inches x ¼ inch. Fits GL1800 01-10 and most trike kits. Single. Optional Add On part 45-1100 Light Grill (shown on mudflap).



18741-179 Mud Flap with Oval LED Light \$79.95
3741-179 Trike Mud Flap with Oval LED Light \$79.95

This mud flap is made of sturdy rubber that can take a beating. Comes with an oval red LED light encased in a chrome oval housing and the hardware to mount. Mud flap measures 10 inches x 7 inches x ¼ inch. Fits GL1800. 01-10 and most trike kits. Single.



18741-176 Mud Flap \$69.95
3741-176 Trike Mud Flap \$69.95

This mud flap is made of sturdy rubber that can take a beating. Comes with a chrome insert, eagle emblem, mounting bracket and the hardware to mount. Mud flap measures 10 inches x 7 inches x ¼ inches. Fits GL1800 01-10 and most trike kits. Single.



Replacement Part	Description	Price
091-6211A1G	Eagle Emblem - updated 3" x 1"	\$7.95
138-316A1	Eagle Emblem - classic 24 3" x 1"	\$6.95
12-6100RR	Oval Red LED Light 7" x 3"	\$14.95
45-1227R	Red LED Reflector Light 1 ¼" x 3 ½"	\$21.95



091-6211A1G



138-316A1



12-6100RR



45-1227R

678-116 Pin Striping \$12.95

This chrome trim creates additional chrome accents anywhere on a bike, trike or trailer. Comes in a 20 foot roll and can be cut to size. Measures ¼ inch wide with one side rounded and the other side flat and uses self-adhesive tape to mount. Single.



678-118 Windshield Chrome Trim \$19.95

The chrome trim fits on the edge of the windshield for a nice chrome accent on the front of the bike or trike. It has universal uses for chrome edging. Measures 1/4 inch in width, has an opening to slip over edges and comes in a 20 foot roll that can be cut to meet desired lengths required. Single.



45-1299-W Wire Connector \$6.95

This easy to use wire connector provides a convenient way to splice or tap two wires together. Wires hold together by placing them in the connector and snapping it closed keeping them securely fastened. Made for 22-26 gauge wires. Perfect for the do it yourself kind of person. 10 pack.



S37734 Chrome Molding \$36.95

This chrome trim is one of the great ways to add some nice chrome accents to give the bike, trike or trailer a uniquely creative look. Comes in a 12 foot roll measuring ¾ inch wide. The trim can be cut to size and installs with self adhesive tape. Single.

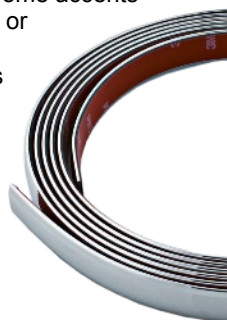

T3605C Chrome Molding Trim \$29.95

This chrome trim is one of the great ways to add some nice chrome accents to give the bike, trike or trailer a uniquely creative look. Comes in an 18 foot roll measuring ¾ inch wide. It can be cut to size and installs with self adhesive tape. Single.



GL1500



Rotor Covers

The Add On designed chrome rotor covers give a great updated look similar to the GL1800. They are ABS chrome and include a chrome mounting strap for a complete look. This is a simple way to replace the weather worn or damaged rotor covers and make the bike look new. Easy to install. Available as lighted with Add On part 15673-224 installed. Other colors available by special order. Fits all GL1500. Pair.

Part	Description	Price
15673-176B	Rotor Covers	\$137.95
15673-176BSL	Rotor Covers with Amber Strip Light	\$189.95



LED Lighted Rotor Cover Trim Rings

These tri-chromed ABS light rings have 38 amber LED lights in each ring with 19 reflecting outward and 19 reflecting towards the rotor cover giving the front of the bike additional visibility. Fits the GL1500. Left and right pair.

Part	Description	Price
45-8134ALED	Amber LED Light Rings	\$92.95
45-8134ARBLED	Red Blue Amber LED Light Rings	\$134.95
45-8134ALED-A	Amber LED Replacement Strips	\$61.95
45-8134ARBLED-A	Red Blue Amber LED Replacement Strips	\$69.95



252-216 Rotor Cover Plugs \$13.95

The chrome plugs fits a 3/4 inch screw giving the bike a finished, show bike look. Used on Add On part 15673-176B Rotor Covers to give them a smooth finished look covering the bolts on the rotor covers. 4 pack.



45-8537 LED Lighted Front Fender Trim \$102.95

Chromed ABS one piece fender accent updates the bike with chrome and LED lights. There are 8 bright amber LEDs on each side to illuminate outward giving more visibility to the bike. These work as running lights. The attractive trim wraps around to the nose of the front fender and attaches with self adhesive tape. No drilling is required to install. Measures 8 inches in length. Fits the GL1500. Single.



Front Fender Side Covers

Replacement front fender covers are made of ABS. Available in chrome and raw. Raw are paint ready to customize. Easy to install, included new grommet for a secure fit. Fits all GL1500. Pair.



Part	Description	Price
45-8733	Chrome	\$139.95
45-8733R	Raw	\$99.95



GR-700 Replacement Grommet for Front Fender Side Covers \$ 7.95 Also fit GL1200 radio, speakers and other Honda bikes. 10 Packs.



GL1500

1646 Tunnel Fillers \$19.95

These foam tunnel fillers fit around the top of the forks and prevent air flow on to the driver for a more comfortable ride during hot, cold or rainy weather. They also keep road debris from blowing up onto the driver. Made in the USA. Fits all GL1500s. Pair.



45-8128A Chrome Windshield Vent Accent Trim \$41.95

This popular ABS tri chromed accent is a great way to add a touch of chrome to the windshield. This trim outlines the windshield vent and very easily attaches with self adhesive tape. Fits all GL1500 vents and Add On standard vents. Single.



15373-236A Chrome Radiator Grill \$83.95

The chrome radiator grill adds a great touch of chrome to the bike. The lightweight, tubular designed grill mounts without removing the lowers on the bike. Fits all 1500s. Single.



45-8907C Front Fender Extension \$33.95

The solid tri-chromed ABS front fender extension provides protection to the front of the engine from road debris. Requires drilling to install and mounting hardware is included. Fits the GL1500. Single.



15673-115 Lower Front Fairing Grill \$20.95

Tri-chrome ABS grill is styled after the look of the 1995 bike and gives the older bike a newer updated look. An easy to install replacement piece. Fits all GL1500s. Single.



15373-232 Fork Bridge Cover \$31.95

The chromed ABS fork bridge cover replaces the OEM cover which is exposed to constant debris from road and weather. A great chrome piece to keep your bike looking like new. Fits all GL1500s. Single.



1601 Winglets \$81.95

By V & P Inc. and made in the USA. This is a clear adjustable wind deflector made of Lexan and attaches to the outside edge of the windshield. Measures 13 inches in length, it requires drilling to install. Fits 1500 & 1200. Pair.

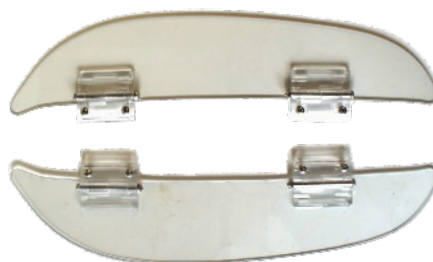

15733-465A Lower Front Cowl \$129.95

Tri-chromed ABS lower cowl replaces the dull gray or weather worn cowl. Improved with wider tabs for better installation. Fits all GL1500s. Single.



15993-119 Driving Light Bar \$61.95

Tri chromed bar mounts to the lower fairing bolts and adds more lighting to the front of the bike for more visibility and safety. Fits all GL1500s. Lights sold separately. Single.



V562-1 Clear Driving Lights \$61.95

Universal 12 volt driving lights can be used for many applications on bikes, trikes or trailers. Each light measures 5 1/2 inches x 3 inches and is encased in a chrome housing and bezel. The lights have a universal mounting bracket and include wiring and relay switch for easy installation. Pair.

Replacement bulbs are Add On part
01-H3 55W \$9.95
01-4530BLB 55W Super White \$19.95



H3C50W H3C LED - H3 Replacement Bulbs \$64.95

Replacement H3 LED of 500 Lumen for Honda fog lights equivalent to a 50W bulb. Direct replacement, plug and play. Works on the GL1800, F6B, GL1500. Pair.



GL1500

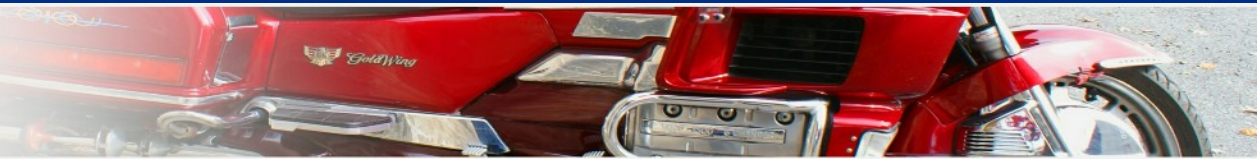

45-8533 Engine Case Guards \$139.95

Beautifully chromed engine case guard replacements protect the engine and work well with all highway boards and pegs with any 1 inch clamp. An Add On exclusive part, they are styled for the 88 to 97 but fit all year bikes. Fits the GL1500. Pair.



45-8144 Corner Light Grills \$41.95

Chrome ABS grills fit over the front corner lights and give the bike an updated look of the 1998-2000 Gold Wing with a 2 bar design. Fits the GL1500s. Pair.



08126-MN530C Exit Air Vent Trims \$27.95

These beautiful tri-chromed ABS flare accents give added chrome in front of the louvers. Fits the 1500. Pair.



1157A Pathfinder High Performance LED Amber Replacement Bulb \$20.00

Replacement 1157 bulb for running/ brake/ turn signal with 450 lumens. Direct replacement, plug and play. Fits the GL1500. Single.



45-8543 98 Style Engine Case Guards \$149.95

Beautifully chromed engine case guard replacements protect the engine and work well with all highway boards and pegs with any 1 inch clamp. An Add On exclusive part, they are styled for the 98 to 00 but fit all year bikes. Fits the GL1500. Pair.



15673-221B Corner Light Kit \$121.95

Replacement corner lights with clear lens design works as turn signal lights. Fits all GL1500s. Pair.



Note: To have them remain on as running lights as well, then you need Add On Part 15673-221 Corner Light Switch Kit



GL1500 LED Low/High Beam Headlight Kit \$155.00

NEW Solid state LED bulbs consists of one low and one high beam. Optimum performance. Plug and play direct replacements. Passive cooling system. Works on a 12 Volt system at 2.3 AMPs per bulb. Color temperature is 5500K, 4800 lumens. Pair.



Part	Description	Price
G158897	Fits 88-97	\$110.00
G159820S	Fits 98-00	\$110.00

01-6245J Replacement Bulb \$2.95

12V 45/45W Bulb - Corner Light Single.



090-140 Front Flasher Kit \$14.95

This kit makes the fairing side running light flash when the directionals are turned on. Fits all GL1500s. Pair.



08170-MN540 Fairing Side Reflector Light Kit \$12.95

The wiring kit changes the existing side reflectors into a running light. Includes 3 watt bulbs and wire harness for both left and right sides. Plug and play unit with existing wiring already on the bike. Fits the GL1500. Pair.



01-194 Replacement bulb \$.98

Single.



GL1500



15673-463 Chrome Mirror Bases \$57.95

The chrome ABS mirror bases replace the OEM mirror mount covers. They add a great touch of chrome giving the bike a classy look. Fits all GL1500s. Pair.



15673-463A Chrome Mirror Backs \$35.95

ABS chrome accents have a fluted design to add style and a great look to the bike. They are an economical way to keep your bike looking new by covering those weather worn or damaged mirror backs. Fits all GL1500s. Pair.



15673-463B Mirror Trims \$44.95

These tri-chromed ABS trim rings attach to the front outside edge of the rearview mirror housings. They add a nice chrome touch to the bike. Fits all GL1500s. Pair.



M60-6611 Adjustable Rear View Mirror \$12.95

This large rear view mirror optimizes your viewing for a safer ride. The mirror is on a swivel to angle as needed. Easy to install with a universal mount or can be permanently attached to the bike's rear view mirror. Available in flat black only. Single.



15132-205A Fairing Light Kit \$50.95

The kit replaces the entire reflector and turns the fairing reflector into a running light. Included are the lights with amber lenses and wire harness. Fits GL1500. Pair.



LED Arrow Lights \$14.95

These 9 amber LED lights have a 2 wire function for brake, running or turn signal. Flashes automatically when wired into the turn signal. Measures 2 1/4 inches x 1 1/2 inches, is encased in a clear housing and mounts to any flat surface with self adhesive tape. Pair.

Part	Color
20-64A8A	Amber
20-64A8R	Red



20-64A8A

20-64A8R



1602S Air Vent Damper Kit \$69.95

By V & P Inc. and made in the USA. These covers mount easily inside the air intakes. Great for cold days, they redirect warm air over the feet. Made of smoke tinted Lexan. Fits GL1500s 88-97. Pair.

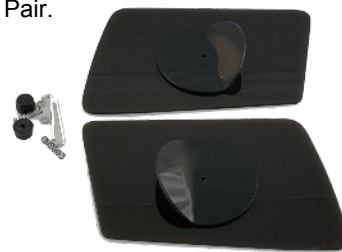

V599 Rear View Mirror \$3.95

An economical universal small rear view mirror measures 2 1/8 inches x 1 1/2 inches x 3/4 inches and attaches directly to the bike's mirrors using self-adhesive tape. It is angled to provide additional viewing towards the rear of the bike. Single.



GL1500

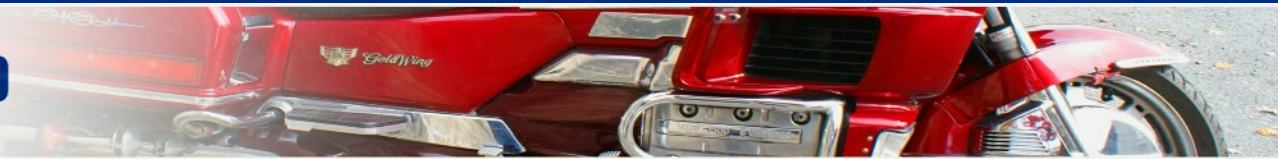

15393-545A1 Driver Floorboard Sets \$399.95

These chrome GL1500 driver floorboards when installed bring the boards down 1 inch from original position. They come with heel-toe shifter pegs, brake pedal and heel rest, and fold-up driver floorboards. Enjoy your ride more with these comfortable boards. Fits all GL1500s. Pair.



15393-545CSR Replacement Rubber Floorboard Mats \$19.95

Replacement rubber mats for Add On Part 15393-545A1. Pair.

38-1133I Shifter Peg \$9.95

Tri-chromed shifter peg includes 3 rubber rings. Single.



38-1133I-R Replacement Rubber Ring \$2.95

Adjustable Highway Boards and Pegs

These are die cast and chromed plated pegs and boards with chrome clamps and chrome mounting arms which attach to the case guards. The mounting arm has 7 possible positions for adjustment to meet the rider's comfort. Fold up feature moves them out of the way when not in use. Fits the GL1500/GL1800 or any 1 inch bar. Pair.

18548A Adjustable Highway Pegs \$218.95



18548C Adjustable Driver Boards \$319.95



18548D Adjustable Comfort Pegs with Heel Rest \$269.95



17-0637JIG Comfort Peg with Heel Rest \$149.95

This complete tri-chromed peg set includes pegs with heel rests and raised rubber inserts, clevis and 3 piece clamps. Fits on any 1 inch rail, such as the engine guards. Great for added riding comfort. Fit all Gold Wings. Pair.



Driver Floorboard Set \$496.95

By MC Enterprises. Cast aluminum floorboards with heel-toe shifter provide convenient shifting and additional comfort for long rides. Mounts to original foot peg mounting location and includes brake extension, heel rest and side stand extension. All hardware is included. Pair.

Part	Description
MC297-8	Fits GL1500 88-94
MC297-95	Fits GL1500 95-00



P77-6003 Custom Highway Pegs \$79.95

These tri chromed billet custom clamps are beautiful and functional. These can be used with adjustable Buffalo pegs with heel rests and highway peg works on any 1 inch bar Economically priced. Pair.

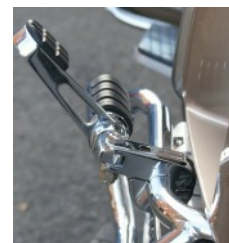

P77-6003B Custom Highway Pegs \$109.95



P77-6003C Custom Highway Pegs with Heel Rest \$155.95



BP-1 Engine Plate \$52.95

This 2 piece engine plate is made of aircraft grade aluminum and uses stainless steel screws for mounting. It protects the underside of the bike, preventing damage caused by road debris, the elements and keeps it cleaner. Designed to allow easier oil changes without removing the lower cowl. Made in the U.S.A. Single.



GL1500

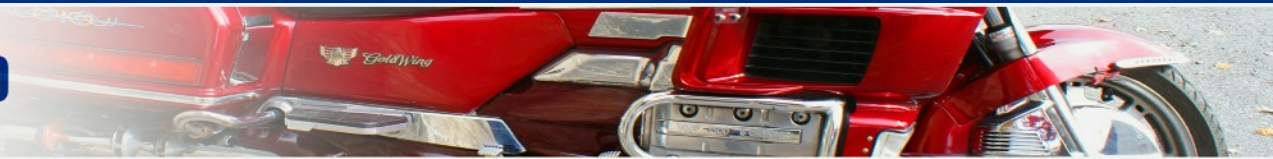

15293-646G Reverse Lever Accent \$16.95

This tri-chromed accent slips over the reverse lever adding a custom look to the bike. Fits the GL1500 1990-2000. Single.



15433-287 Cam End Cover \$18.95

This beautiful chrome cover replaces the OEM cover adding a great chrome accent. Fits the GL1500 and Valkyries. Single.



15673-117 CB Accent \$18.95

This chrome plate dresses up the area around the CB radio. Uses self-adhesive tape to mount. Fits all GL1500s. Single.



15673-123A Fairing Vent Accents \$19.95

These chrome accents outline the air exit vents below the CB radio and air compressor. Uses self-adhesive tape to mount. Fits all GL1500s. Pair.



15673-137A Gas Tank Side Trims \$40.95

These chrome accents fit along the gas tank and curve under the air exit vents. Uses self-adhesive tape to mount. Fits all 1500s. Pair.



15673-123B Lower Gas Tank Trims \$42.95

These chrome accents outline the lower air exit vents and wrap back over the gas tank. Uses self-adhesive tape to mount. Fits all GL1500s. Pair.



64286/96-MT2 Chrome Fairing Plugs \$8.95

The tri-chromed ABS fairing plugs replace the OEM plugs on the bike adding a nice touch of chrome. These are designed with a recessed surface to give them style. Fit the GL1500. Pair.



15373-426 Carburetor Covers \$59.95

These are beautiful chrome OEM carburetor cover replacements. These will keep your classic bike looking great all the time with new chrome. Fit all GL1500s. Pair.



15673-136 Air Compressor Trim \$17.95

This chrome accent dresses up the area around the air compressor controls. Fits all GL1500's. Single.



GL1500

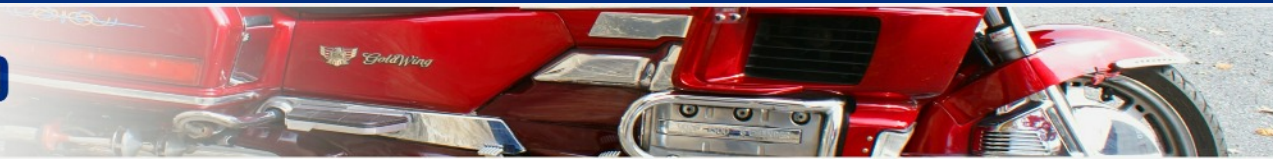

45-8731 Chrome Rear Side Covers \$188.95

Tri-chromed ABS rear side covers are a very economical way to replace weather worn or scratched covers and give the bike a great dramatic look of chrome. They are an OEM replacement and include new grommets to ensure a secure fit. Fits the GL1500. Pair.



15373-471 Lower Side Covers \$84.95

The tri-chrome ABS lower engine covers have gentle ridges on the lower half giving them a great design pattern. They will stand out nicely and will give any GL1500 a show bike look or just update those classic bikes with these beautiful chrome side pieces. The covers are a direct replacement for the O.E.M covers on the bike. Fits all GL1500s. Pair.



HST-2 Replacement Side Cover Studs \$36.95

Made in the U.S.A. These are high quality replacement studs perfect for Honda street and touring bikes. Two studs are provided with each measuring about 2 3/4 inches in length and 9/16 inch diameter. They are easily cut or filed down to obtain the length required for the repair work. Adhesive is included for mounting. It is recommended that new grommets be purchased for a good hold if the original ones are in poor condition. Pair.



HST-2A Studs Only \$26.95 Pair.

8265-S J-B Weld only \$7



45-8731R Raw Rear Side Covers \$150.95

Unfinished ABS rear side covers are a very economical way to replace OEM covers on the bike that may be weather worn or scratched. The unfinished covers can be painted to match your bike or customized. They are an OEM replacement and include new grommets to ensure a secure fit. Fits the GL1500. Pair.



673-226A Side Cover Rails \$34.95

These tri-chromed rails wrap around the Gold Wing emblem on the side covers to add style and protection to the bike. Fits the GL1500 and GL1200. Pair.



GR-700 Side Cover Grommets \$10.95

Replacement grommets for the side covers. Kit consists of 8 rubber grommets. Fits GL1500. 8 Piece.



GL1500

15293-648DC Brake and Clutch Levers \$40.95

These tri-chromed brake and clutch levers are a direct replacement for the OEM levers. Fits the GL1500 90-00 and GL1200 SE-LTD and Valkyrie. Pair.



293-646DC Brake and Clutch Levers \$21.95

Tri-chromed brake and clutch levers replace the OEM levers on the bike. Fits the Goldwing GL1200 84-87 Limited Edition, Special Edition, 87 Aspencade and GL1500 88-89. Pair.



Hand Warmers \$81.95

By V & P Inc. and made in the USA. These shields protect the rider's hands from wind, rain, and cold weather. Made of poly carbonate, they attach to the brake and clutch levers using existing hardware. Fits GL1500 and GL1800s. Pair.

Part	Color	Part	Color
1634	Bronze	1635	Clear



1634



1635

45-1237HGR Rist Rest© \$24.95

The chrome ABS Rist Rest© works with heated grips as well as non-heated grips. A beautiful universal throttle assist will give you more comfortable miles with its extra large 2½ inch rest with rubber insert. The Rist Rest© has elongated slots to make it adjustable to fit most 4 screw end cap replacement grips including the heated grips on the GL1500 and GL1800. They come with longer screws and an Allen wrench for easy installation. Fits right side only. Single.



45-1243 NOVIBE© Comfort Grips \$99.95

Tri-chromed grips with cushioned rubber rings are as beautiful as they are comfortable. The rubber rings go completely around the grips and provide a comfortable hold at all times. Easy to install, they work on any 7/8 inch grip with or without the damper. Comes with interchangeable grip ends and hardware to adapt to different bikes. Pair.



670-839 Chrome Kill Switch Accent \$9.95

The tri-chromed kill switch cover goes over the one on the bike adding a nice touch of chrome. It has an indicator line to identify positions. Mounts with self-adhesive tape. Fits the GL1500 and GL1800. Single.



393-617R Rail Grips \$35.95

These die cast rail grips fit handlebars measuring 150 mm x 7/8 inch. Grips have soft rubber inserts with chrome overlay. They have smooth chrome ends for a clean finish. They will fit all Goldwings. Pair.



393-617RH Road Hawk Grips \$22.95

By Emgo. Classic grips with soft black foam and chrome end caps embossed with a chrome eagle emblem and red "Roadhawk". A great economical set of grips. Fits any 150 mm x 7/8 inch bar. Fits all Goldwings. Pair.



GL1500

15673-187R Right Master Cylinder Cover \$42.95

Accessory switches at your finger tips. The tri-chromed ABS cover fits over the master cylinder and attaches with a screw. The kit includes 4 rocker switches and a wire harness. Fits all GL1500s. Single.

673-187R Red Rocker Switch \$2.95



15678-021 Helmet Holder Stud \$15.95

This chrome helmet holder stud is a convenient holder for helmets or other items when making quick stops. The stud replaces the lever bolt on either side of the bike. Fits all GL1500s and GL1800s. Pair



4553-MN5 Handlebar Clamp Plugs \$8.95

The tri-chromed ABS plugs cover the screw holes and add a nice touch of chrome to the handlebars. Easy to install by just snapping in. Fits the GL1500 and 1800. Pair.



Master Cylinder Top Covers These tri-chromed master cylinder covers dress up the handlebar area of the bike. They replace the OEM reservoir covers on the bike and include chrome screws. Fits all GL1500s and GL1800s.

Part	Description	Price
57-1097C	Chrome with Eagle and "Free Spirit" - Single	\$15.95
57-1097CG	Chrome with Gold Eagle and "Free Spirit" - Single	\$29.95
15793-204P	Plain Chrome - Pair	\$27.95
57-1097CG-S	Chrome Screws - use for all Goldwing Master Cylinder Covers - Pair	\$1.95



MK-D Driver Mugger Drink Holder \$19.95

The economical drink holder is designed to attach to the handlebar clamp screws with a chrome ABS mounting bracket. The drink holder swivels to prevent drinks from spilling and the holder folds-up when not in use. Holds a 12 ounce drink can with adjustable arms. Black. Fits the GL1500 and GL1800. Single.



15503D Drink Holder Mount \$21.95

This is a tri-chromed universal mount which attaches to the master cylinder. There are a variety of holes to allow for the attachment of drink holders, electronics and other items to put at your fingertips. Single.



H1511 Left Hard Pocket \$57.95

This hard cover replaces the soft left fairing pocket on the GL1500. Made of sturdy plastic, it includes a latch to secure the door and keep items from falling out, providing additional protection for your valuables. An Add On exclusive part. Fits the GL1500. Single.



15673-121 Right Glove Box Accent \$32.95

A tri-chromed ABS accent fits over the right glove box and is a great way to dress up the front dash area of the bike. Uses self-adhesive tape to mount. Fits all GL1500s. Single.



15673-235 Chrome Radio Knobs \$25.95

Set of ABS chrome radio knobs with indicators to replace the black knobs and add nice accent to the dash of the bike. Use original clips for installation. Fits all GL1500s. Set of 5.



GL1500

15673-134 Front Speaker Grills \$46.95

Dress up your GL1500 with these beautiful Add On designed chromed front speaker grills. The chrome outlines the outer edges of the speaker with a single chrome bar across the middle. To enhance their appeal, there are optional eagle emblems added to give a show bike appearance to the grills. Mounts with self-adhesive tape. Fits all GL1500s. Pair.



15673-148 Head Light Adjustment Knob \$12.95

Chromed ABS knob replaces the OEM knob. Fits all left sides GL1500 88-00 and the right side on the GL1500 SEI. Single.



15673-123 Air Vent Accent \$15.95

This chrome accent fits around the air vent and comes in pairs. Uses self-adhesive tape to mount. Fits all GL1500s. Pair.



15673-159A Fuel Door Accent \$21.95

This chrome accent outlines the fuel door with a 3/4 inch of chrome trim adding to the classy look of the bike. Uses self-adhesive tape to install. Fits all GL1500s. Single.



45-8541 Key Switch Accent \$13.95

Tri-chromed ABS key switch accent completely replaces the OEM switch. It is an inexpensive way to dress up the dash area on the bike and it helps protect the key area. Easy to install by twisting out and and securely locking in place. Fits all GL1500s. Single.



45-8531 Fader Control Knob \$7.95

Tri-chrome replacement fader control knob replaces the factory black knob on the bikes. Fits GL1500 SEI 92-00. Single.



45-8538 Radio Accent \$29.95

This beautiful chrome accent covers the radio panel making a great chrome addition to the dash area of the bike. Uses self-adhesive tape to mount. It can be paired with Add On part 45-8539, chrome cassette door latch accent for a complete look. Fits the GL1500 88 to 95, except the SE or Interstate. Single.



15673-159B Dash Side Accents \$38.95

These chrome accents run along the left and right side of the radio and add a nice touch of chrome. Installs with screws and self-adhesive tape. Fits all GL1500s. Pair.



15673-159C Dash Accent \$19.95

This 2 piece tri-chromed accent outlines the area of the bike below the ignition key. Adds a great touch of chrome to the dash area. Uses self-adhesive tape to install. Fits all GL1500s. Single.



45-8539 Cassette Door Accent \$14.95

The chromed accent piece fits over the cassette door latch on the GL1500. Easy to install with self adhesive tape. Works nicely with Add On part 45-8538, radio panel accent. This can be used alone or with other chrome accents. Fits all GL1500s. Single.

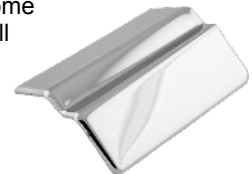

GL1500

15673-817K Black Driver Backrest \$219.95

Side mounted backrest provides a comfortable ride for the driver. It has a tubular mounting bracket with side arms that allow the backrest to adjust by moving it forward or back and has a fold down pad. Comes with chrome loop, black backrest pad with permanently attached storage pouch and hardware to mount. Fits all GL1500s. Single.



45-1706-K Chrome Adjustment Knob \$17.95

45-1706R Nylon Compression Ring \$3.95



678-034B Black Beaded Seat Cover \$29.95

The black beaded seat cover will give the rider a more comfortable ride by allowing air to circulate between the user and the seat to help keep you cooler in hot weather or dryer when it is raining. It is one inch larger than any others on the market and the rounded beads make long distant travel more enjoyable. Easy on and off with a bungee cord system. Measures 11 inches x 16 inches. Fits the GL1500 and GL1800 driver seats and can fit many other seat styles that can accommodate this size. Single.

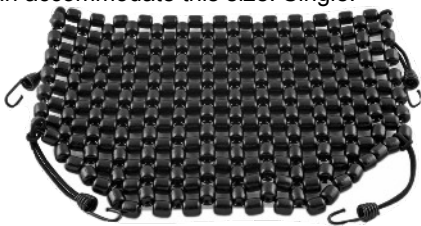

15673-629 CB Antenna \$109.95

CB radio antenna works on all the GL1500's and comes complete with all the mounting hardware. Comes with a fold down feature to make it easier to store the bike or cover. Single.

Part	Description	Price
18673-629AA	Antenna Tip Only	\$5.95
45-1810-A/D	Antenna Tip and Staff	\$48.95
45-1810-P	Swivel Pin	\$5.95
45-1810-S	Set Screw	\$3.95



15673-818K Black Passenger Armrest \$153.95

These armrests provide a more comfortable ride for the passenger. The swing out feature allows easy access on and off the bike. Comes with chrome mounting brackets, black pads measuring 10 inches x 5 inches x 3 inches and hardware to mount. The black passenger armrests are made of the same type of fabric as OEM. They mount to antenna base and **require two antennas to mount**. Fits all GL1500s. Pair.



Armrest LED Light Kit

A great way to add extra lights and visibility to the side of the bike. The kit mounts to the armrest mounting plate with self-adhesive tape and is finished off with a star washer to add a decorative touch. Fits the GL1800 and GL1500 bikes with armrests. Pair.



MK-P Passenger Drink Holder \$19.95

The economical drink holder is designed to attach underneath the armrest with a chrome ABS mounting bracket. The drink holder swivels to prevent drinks from spilling and the holder folds-up when not in use. Holds a 12 ounce drink can with adjustable arms. Black. Fits the GL1100, GL1200, GL1500 and GL1800. Single.



Part	Color	Price
104-A	Amber	\$59.95
104-B	Blue	\$59.95
104-F	Multi Flashing	\$61.95
104-W	White	\$59.95

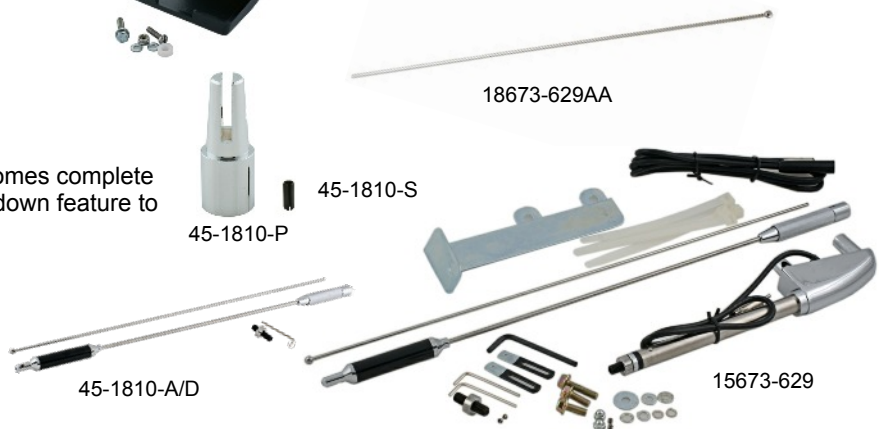

GL1500

15993-191A Trunk Rack \$91.95

This tri-chromed large rack is a tubular design to be used with or without a lighted spoiler. There are two utility tabs for attaching storage bags, flag poles or bungee cords. Comes with mounting hardware. Measures 12 inches x 22 inches. Fits the GL1500. Single.



15678-824 Rear Speaker Kit \$54.95

This rear speaker kit includes two 4 inch speakers, wire harness and fader switch. It fits all the GL1500s except the 1991 10th anniversary Interstate model which has no wiring for this part. Single.



Part	Description	Price
15678-824W	Fader Switch and Wire Harness	\$31.95
678-824	4 Inch Speakers - Pair	\$24.95

501-113A Trunk Rack Pads \$13.95

The set consists of 4 chrome star washers and 4 black rubber washers and is ideal for mounting trunk racks or rails on the bike. Each measures 1 1/2 inch in diameter. 4 Pack.



15678-158A Rear Speaker Grills \$31.95

This chrome ABS accent replaces the OEM black grills really adding to the look of the bike. Fits all GL1500s. Pair.



45-8732 Chrome Rear Pouch Accents \$10.95

The tri-chrome ABS accents fit on the rear pouch door latch on each side of the bike. A small chrome accent is a great contrast against the black OEM material on the bike. Uses self-adhesive tape to mount. Fits the GL1500. Pair.



090-141 Rear Flasher Kit \$14.95

This makes the side trunk lights flash when the directional's are activated. Fits the GL1500. Pair.

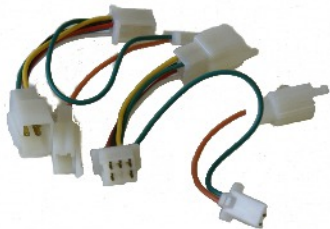

08170-MN530 Trunk Side Reflector Light Kit \$19.95

This kit converts the side reflector into running lights. Fits the GL1500.

Replacement bulb is **01-194A \$0.95**



15993-197A Trunk Handle \$25.95

Tri-chromed tubular designed handle makes it easy to access the trunk. Measures 7 1/2 inches and mounts on flat surfaces. Fits all GL1500 bikes and many other bike, trike or trailer trunks. Single.



670-013B Deluxe Trunk Handle \$50.95

Tri-chrome tubular design trunk handle has a wide comfort foam grip, most useful in very hot or cold weather conditions. Measures 17 inches in length. Fits the GL1200, GL1500 and trunks allowing for this size. Single.



GL1500

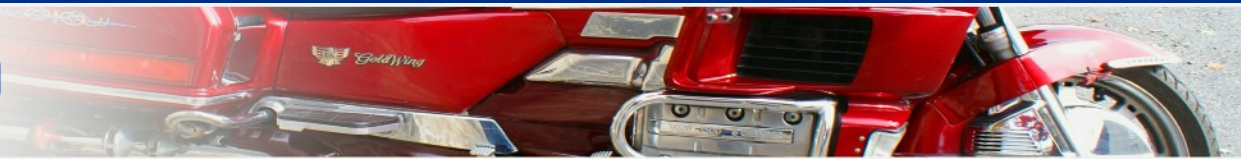

08170-MN520 Rear Reflector Light Kit \$47.95

Converts the saddlebag rear reflector into a light. Fits the GL1500. Single.

01-97 Replacement bulb \$.98



15993-199A Saddlebag Door Rails \$59.95

Tri-chromed tubular designed double rails protect the top and front of the saddlebags. Drilling is required with a 3 point mount and hardware is included. Fits the GL1500. Pair.



15673-141 Lower Saddlebag Kick Plates \$31.95

These chromed plates fit the lower part of the saddlebags by the passenger's floorboard. Provide protection to the bike and add a nice chrome accent at the same time, they are a good way to hide scratches or other damage to this part of the saddlebags. Attaches with self-adhesive tape. Fits all GL1500s. Pair.



45-8929A Saddlebag Side Light Kit \$74.95

This light kit turns the saddlebag reflectors into running lights adding more visibility to the bike. This is a complete replacement of the side reflectors and includes the light unit with a red lens over 6 lights and a wire harness. Fits the GL1500. Pair.



01-194 Replacement bulb \$.98



V391C Interior Light \$14.95

This small interior light is perfect for the trunks of most bikes. Easy to install and wires in so you will always have light. The polycarbonate 12V interior light comes with a nylon switch for easy on and off operation. It has a metal base surface and mounts with screws on a 3 1/2 inch center. Separate ground and lead wires are supplied for electrical connection. Measures 1 3/4 inches x 3 1/2 inches x 4 9/16 inches. Single.



45-8945 Trailer Wire Harness \$35.95

A plug and play trailer wire harness with relays allows the current from the trailer lights to be drawn directly from the battery using stock lighting circuits. Fits GL1500. Single.



Helmet Locks The tri-chrome extension attaches to the trunk helmet holder latch making it easy to hang the helmet when not in motion or when there is not room in the trunk. It slips through the D-ring on your helmet to make it easier to attach the helmet to the helmet holder latch under the trunk. A more convenient way to stow the helmet.

Part	Description	Price
77-6021	Bike - Single - 3 1/2" x 2 1/2"	\$8.95
77-6022	Trailer - Single - 3 1/2" x 2 1/2"	\$8.95
993-135	Plain - Pair - 3 1/2" x 1 1/2"	\$10.95
993-136	Nolan Helmets - Pair - 4" x 1 1/2"	\$14.95



77-6021



77-6022



993-135



993-136

GL1500

Cooler Rack \$153.95

This well engineered rack can carry heavy loads and is constructed of light weight durable aluminum that will not rust. This rack can be used with a horizontal receiver with a 1 ¼ inch opening. The rack measures 11 inches by 16 inches with a solid 1 inch frame edge with holes to attach bungee cords and a grate floor. Made in the U.S.A. Fits the GL1500 with a horizontal trailer hitch or any horizontal receiver with a 1 ¼ inch opening. Single.

Part	Color
678-037	Natural
678-037B	Black Painted

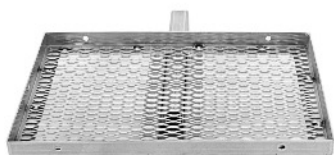

678-037



678-037B



LED Running and Brake Light Bulb \$19.95

This dual filament LED bulb will convert and update the 1157 bulbs on older bikes. Special order. Single.

Part	Color
LED-1157RED	Red
LED-1157W	White



LED-1157RED



LED-1157W

45-8943 Lighted License Filler Accent \$82.95

The tri-chromed ABS license filler accent has 60 bright red LED lights to call attention to the rear of the bike. The accent fills in the area along the sides and bottom of the license plate with chrome and the lights are arranged in a segmented double row on the lower portion. Works as a running and brake light, it is easy to install with self-adhesive tape and includes a 36 inch lead wire. Fits the GL1500. Single.



Mud Flap Made of sturdy rubber that can take a beating. Comes with or without a light, mounting bracket and the hardware to mount. Mud flap measures 10 inches x 7 inches x ¼ inches. Fits all GL1500s and most trike fenders. Single.



15741-176/3741-176



15741-179/3741-179



15673-180/3741-180

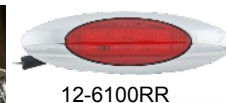

12-6100RR



091-6211A1G

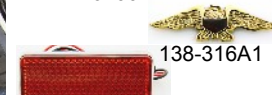

138-316A1



45-1100

Part	Description	Price
15741-176	Chrome insert with eagle emblem	\$69.95
3741-176	Trike with chrome insert with eagle emblem	\$69.95
15741-179	LED red oval light	\$79.95
3741-179	Trike with LED oval light	\$79.95
15741-180	LED red rectangle light	\$89.95
3741-180	Trike with LED red rectangle light	\$89.95

Part	Replacement Parts	Price
091-6211A1G	Gold eagle emblem 3" x 1" - Single	\$7.95
138-316A1	Gold eagle emblem 3" x 1" - Single	\$6.95
12-6100RR	Oval red LED 7" x 3" - Single	\$14.95
45-1227R	LED Reflector 1 ¼" x 3 ½" - Single	\$21.95
45-1100	Reflector Grills - Pair	\$14.95

15303-283A Triple Exhaust Extension \$170.95

These tri-chrome extensions add a custom look to the bike with their triple turndown pipes. The clamp on design allows the baffle to remain in. Diameter of the opening is 2 ½ inches, the length is 13 inches and width at widest point is 6 ½ inches. Fits GL1500 1988-97. Pair.



1157R Pathfinder High Performance LED Red Replacement Bulb \$20.00

Direct replacement for the 1157 bulb for applications such as turn signals. Dual filament, 450 lumens. Plug and play. Fits the GL1500. Single.



GL1200-1000



373-175 Caliper Covers \$84.95

Tri-chromed steel covers have a black and gold trim inlay adding a nice chrome accent to the front of the bike. Fit the Goldwing GL1100 1983 ASP and all GL1200. Pair.



423-325A Chrome Front Fairing Vents \$39.95

Chrome ABS grill goes on the outside front fairing next to the turnsignal lights. Fits the GL1200 1985 - 1987. Pair.



V562-1 Driving Lights \$61.95

Universal 12 volt driving lights can be used for many applications on bikes, trikes or trailers. Each light measures 5 1/2 inches x 3 inches and is encased in a chrome housing and bezel. The lights have universal mounting brackets and include wiring and a relay switch for easy installation. Pair.

01-H3 55W \$9.95

01-4530BLB 55W Super White \$19.95



363-210 Oil Filter Bolt \$19.95

This steel bolt has a standard 17mm head and is designed as a direct replacement equivalent to Honda OEM Part # 15420-300-020 .Fits on all GL1000, GL1100 and GL1200. Single.



MC660-5 Front Fender Trim \$174.95

By MC Enterprises. Chrome double rail wraps around the front fender trim to provide protection and adds a stylish accent to the front of the bike. The trim has a small plate to mount an emblem or light and it is tri-chrome for durable good looks. Includes all mounting hardware. Fits all GL1200s. Single.



H3C50W Pathfinder LED Performance LED Bulb. \$64.95

Direct replacement bulb for most H3 applications of 50W equivalent brightness. Plug and play. 600K color temperature. Pair



733-286 Front Fender Extension \$43.95

Chrome ABS front fender extension adds a nice chrome accent to the front of the bike while also providing protection from road debris. The piece has a black rubber insert on the back. Requires drilling to install. Fits all GL1200. Single.



Strip Lights

By Vista Manufacturing. The strip light is encased in a chrome channel for easy mounting on any flat surface with 2 screws and adds a decorative look to the light. The lights have 3 inch spacing and includes a 36 inch lead wire. These quality lights have extended lamp life and lower amp draw. Works as a running, brake or turn signal light. Made in the U.S.A. Single.

Size	Amber Part	Red Part	Price
6"	420-410A-6	420-410-6	\$10.95
9"	420-410A-9	420-410-9	\$10.95
12"	420-410A-12	420-410-12	\$15.95
20"	420-410A-20	420-410-20	\$25.95



GL1200-1000



673-142A Headlight Visor with Bezel \$39.95

This tri-chrome ABS accent adds protection as well as beauty to the bike. The chrome headlight bezel incorporates a grill to add style to the front of the bike. A great way to keep your older bike looking new. Fits all GL1200. Single.



GL1200 Replacement Mirrors \$54.95

This is an OEM mirror replacement with black housing and silver matte finish backing plate. Fits the GL1200 85-87. Single.

Part	Description
823-145C	Left Mirror
823-146C	Right Mirror



423-262A 7 Inch Headlight Visor \$26.95

Tri-chromed visor adds protection and a great chrome accent to the front of the bike. The visor is plain and has a curved design. Fits GL1100 and any 7 inch headlight. Single.



1601 Winglets \$81.95

By V & P Inc. and made in the USA. This is a clear adjustable wind deflector made of Lexan and attaches to the outside edge of the windshield. Measures 13 inches in length. It requires drilling to install. Fits the 1200 and GL1500. Pair.



733-463A Chrome Mirror Backs \$36.95

The mirror back accents have a silver matte finish to replace the weather worn accents and help make your classic bike look new again. They mount with self-adhesive tape. Fits the GL1200. Pair.



673-226A Side Cover Rails \$34.95

These tri-chromed rails wrap around the Gold Wing emblem on the side covers to add style and protection to the bike. Fits the GL1200 and GL1500. Pair.



114A Amber Side Marker Lights \$16.95

The amber light will add more visibility to the front fairing or can be used as marker lights. Fits the GL1100 Interstate and Aspencade only. Pair.

Replacement parts:
01-53 Bulb, Single, \$0.98
55-15A Amber Lens, Single, \$2.95

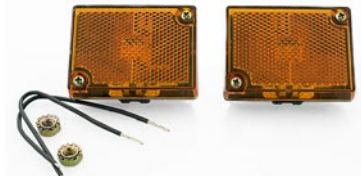

18-625A LED Side Marker Light \$42.95

Replace the reflector on the caliper with this LED amber light. Fits the GL1200 84-87 and GL1800 Caliper Cover Light. Pair.

Optional:
45-1100 Reflector Grills Pair, \$14.95
423-161AL Amber Lens Pair, \$4.95



GL1200-1000



393-540 GL1000-GL1100 Driver Floorboards \$214.95

Driver floorboards with heel-toe shifter and brake pad make riding your classic wing more enjoyable. Set includes chrome mounts, floorboards with rubber mats and all the hardware and instructions to install. Fits the GL1000 and GL1100. Pair.



MC298 GL1200 Driver Floorboards \$519.95

By MC Enterprises. These driver floorboards come with chrome mounts, rubber mats, heel and toe shifter, and all the hardware and instructions to install. Fits the GL1200. Pair.



45-8720 Shifter Pad \$9.95

A tri-chromed replacement driver floorboard shifter pad has a black rubber insert. The pad also has universal applications with a screw mount. Single.



293-302 Chrome Kickstand Extension \$9.95

Tri-chrome kickstand extension makes it easier to lift or put down the kickstand. Fits any O.E.M. kickstand for the GL1000, GL1100 and GL1200. Single.



393-304A Chrome Kickstand \$59.95

Tri-chromed kickstand has a larger and wider foot for a more stable side stand and replaces the OEM kickstand. Includes chrome spring and bolt. Fits the GL1000, GL1100 and GL1200. Single.



673-139 GL1200 Carburetor Tops \$34.95

Tri-chromed carburetor top covers replace the dull gray weather worn top covers on your bike. Gives new life and keeps your older bike looking new. Fits the GL1200s. Pair.



293-303 Kickstand Spring and Bolt Kit \$6.95

A replacement chrome plated spring and bolt for the kickstand. Fits the GL1000, GL1100 and GL1200. Pair.



HST-2 Replacement Side Cover Studs \$36.95

Made in the U.S.A. Replacement studs for Honda street and touring bikes. Two studs measuring about 2 3/4 inches in length and 9/16 inch diameter. Easy to cut or file to size. Adhesive is included. It is recommended to replace old grommets. Pair.

8265-S J-B Weld only \$7.95 Single.

HST-2A Studs Only \$26.95 Pair.



GL1200-1000



17-7503 Fairing Wind Deflectors \$59.95

Adjustable fairing wind deflectors have single smoke wings, chrome mounting brackets and hardware to install. They attach to the fairing trim edge and require drilling to install. Allows the driver to adjust the air flow for a more comfortable ride. Fits GL1100 and GL1200s. Pair.



Chrome Levers Tri-chromed brake and clutch levers replace the OEM levers on the bike. Pair.

Part	Descriptions	Price
293-644DC	GL1200 84-87 Interstate and 84-86 Aspencade.	\$26.95
293-646DC	GL1200 84-87 Limited Edition, Special Edition, 87 Aspencade and GL1500 88-89.	\$23.95

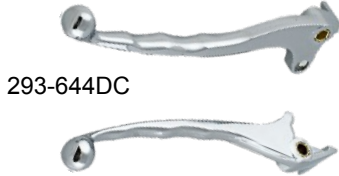

293-644DC



293-646DC

Grips Tri-chrome grips offer a more comfortable ride providing a cushioned hand hold. Each fits all the Goldwings. Pair.

Part	Description	Price
45-1243 NOVIBE® Comfort Grips	Cushioned rubber rings encircle the entire grip. Fits any 7/8 inch grip with or without the damper. Comes with interchangeable grip ends and hardware to adapt to different bikes.	\$99.95
393-617R Rail Grip	Die cast rail grips have soft rubber inserts with chrome overlay. 150 mm x 7/8 inch.	\$35.95
393-617RH Road Hawk Grips	Soft black foam with chrome end caps embossed with a chrome eagle emblem and red "Roadhawk". Fits any 150 mm x 7/8 inch bar.	\$22.95



45-1243



393-617R



393-617RH

798-162 GL1000-1100 Handlebar Clamp \$25.95

The tri-chromed die cast handlebar clamp includes an eagle emblem. This is a great accent for the older bikes to make them look new again. Includes chrome hardware for mounting. Fits the GL1000 and GL1100. Single.



793-204S Master Cylinder Top Cover \$19.95

Tri-chromed master cylinder top cover comes with a gold eagle emblem. It uses the original screws to mount or use Add On part 57-1097CG-S, chrome screws, sold separately. Fits the GL1200 and GL1100 82-85 without diaphragm. Single.

57-1097CG-S Chrome Screws. Pair. \$1.95



57-1097CG-S

673-824 Tape Deck Accent \$12.95

The chrome accent goes around the tape deck. Make the classic bike look new again. Fits all GL1100. Single.



45-1237HGR Rist Rest® \$24.95

The chrome ABS Rist Rest® works with heated grips as well as non-heated grips. It is an extra large 2 1/2 inch rest with rubber insert. The Rist Rest® has elongated slots to make it adjustable to fit most 4 screw end cap replacement grips including the heated grips on the GL1800. They come with longer screws and an Allen wrench for easy installation. Fits right side only. Single.



GL1200-1000



673-133 GL1200 Speaker Accents \$39.95

Tri-chromed front speaker grills have center vertical slots and side cutouts. They brighten up the dash with chrome and add newness to the wing. They mount with self-adhesive tape. Fits the GL1200. Pair.



673-137 GL1200 Fuel Door Accent \$24.95

The tri-chromed fuel door accent adds a great flash of chrome to the tank. A great chrome addition to keep your older bike looking new. Fits the GL1200. Single.



IRC871 Radio Bezel \$41.95

The radio bezel has a universal fit to work on most aftermarket radios. Drilling is required to mount and hardware is included. Measures 11 7/8 inches L x 2 7/16 inches W x 1 9/16 inches H; radio opening 7 3/16 inches L x 2 1/8 inches W; and center hole to center hole is 1 11/16 inches for drilling. Fits the GL1200 Interstates or radios fitting these dimensions. Single.



673-165A GL1200 Handlebar Clamp \$47.95

Tri-chromed ABS handlebar clamp cover replaces the worn out, weather beaten covers with new chrome. It includes two insert panels to accommodate use on both the Interstate and Aspencade models. Fits the GL1200 Interstates and Aspencades 85-87 but does not fit the GL1200 LTD or SE-I models. Single.



678-021 Helmet Stud \$7.95

This tri-chromed stud screws into the unused 10 mm mirror mounting hole on most motorcycles. A convenient piece, it helps to temporarily hang the helmet or other items when the bike is parked. Fits the GL1100 and GL1200. Single.



373-102 Swing Arm Caps \$19.95

Tri-chromed steel caps come with an eagle emblem and add a nice chrome accent to the swing arm on all GL1100 and GL1200 bikes. Pair.



Drink Holder The fold up drink holders can accommodate a 12 ounce drink can and attach with chrome ABS mounting plate. Hardware is provided. Single.

Part	Description	Price
MK-D	Driver Mugger attaches to the master cylinder	\$19.95
MK-P	Passenger Mugger attaches to the armrest	\$19.95
15503D	Universal Mount attaches to the master cylinder and also holds other devices	\$21.95



132-205A GL1200 Turnsignal Light Kit \$40.95

Converts the trunk side lights into a turn signal and running light. The kit contains mounting hardware and both amber and red lenses to give the option of corner light color. Fits all GL1200s. Single.



01-1821-1 Replacement bulb 15W \$.98



GL1200-1000



Black Driver Backrest \$215.95

The black backrest provides a more comfortable ride for the driver. The backrest pad is adjustable and can fold down. Comes with chrome loop, black backrest pad with permanently attached storage pouch and hardware to mount. Fits the GL1200 and GL1100. Single.

Part	Fitment
673-816K	GL1100 Driver Backrest
673-817K	GL1200 Driver Backrest
673-818K	GL1100 Passenger Armrest
673-819K	GL1200 Passenger Armrest



GL1100 Armrest 673-818K



GL1200 Armrest 673-819K

Black Passenger Armrest \$189.95

The black armrests provide a more comfortable ride for the passenger. The fold down feature allows easy access on and off the bike. Comes with chrome mounting brackets, thick black pads measuring 10 inches x 5 inches x 3 inches and hardware to mount. Fits the GL1100 and GL1200. Pair.



GL1100 Backrest
673-816K



GL1200 Backrest
673-817K

673-134 Chrome Horn Covers \$31.95

These tri-chromed steel horn covers have a slotted design to provide protection to your horns. Keeps your older bike looking new. Fits the GL1000, GL1100 and GL1200. Pair.



673-134A Chrome Horn Cover \$15.95

Same as above but fits the Valkyrie. Single.

424-062A Antenna Relocation Bracket \$7.95

The relocation bracket moves the antenna down and out of the way when adding a trunk light bar to the trunk. Fits the GL1100 and GL1200. Single.



678-836 Replacement Trunk Rack Kit \$9.95

The universal trunk rack kit can be used for mounting luggage racks or rails on any bike, trike or trailer. The set has 4 each of 3/4 inch washers, 3/4 inch dome washers, 1 1/4 inch Allen head screws and 8 3/4 inch rubber pads. 4 pack.



Trunk Lid Handle Tri-chromed handle fits the trunks of the GL1200, GL1500, trailers and most other trunk lids with these lengths. Drilling is required to mount. Single.

Part	Description	Price
670-013B	17 Inches - with black foam covered handle for comfort in any weather	\$50.95
15993-197A	7 1/2 inches	\$25.95



45-1706-K Replacement Backrest Chrome Knob \$17.95 Fits GL1200.
45-1706R Replacement Nylon Compression Ring \$3.95 Fits GL1200.

673-629 Type 3 Radio/CB Antenna \$49.95

This is a quality OEM replacement type 3 radio and CB antenna. It can be used on both sides of the bike. Fits the GL1100 and GL1200. Single.

673-629AA Replacement tip only \$9.95



673-815 Trunk Rack \$99.95

Tri-chrome tubular bar design trunk rack, includes two tabs for mounting flag poles or bungee cord hooks to secure parcels on the rack. Measures 22 inches wide x 12 inches deep x 2 1/2 inches high. Fits the GL1100 and GL1200 and other bikes and trikes that accommodate this size rack. Single.



993-190 Trunk Relocation Kit \$59.95

The chrome kit relocates the trunk by moving it back to give the passenger more room behind the driver. The bracket allows for 3 different positions for moving the trunk from 1 inch to 2 13/16 inches. Fits the GL1100 and GL1200 except for the 82 model. Single.



GL1200-1000



993-184 GL1200 Saddlebag Bent Rails \$54.95

The tri-chrome rails bend over the front of the saddlebags to provide protection and add a great chrome accent. Drilling is required to mount. Measures 16 inches end to end with 13 inches sitting on top of the bag. The double rails are 3 1/4 inches apart. Fits the GL1100 and GL1200. Pair.



993-181 GL1100 and GL1200 Trailer Hitch \$159.95

The trailer hitch is made of steel, has a chrome plate to hold the ball and includes all necessary mounting brackets and hardware to mount on bike including a 1 7/8 inch chrome trailer ball. Fits the GL1100 and GL1200 except for the 84 and 85 Aspencade which needs a modification to the bracket. Single.

Replacement Parts
993-181A Chrome 1 7/8" Trailer Ball \$22.95
673-181 Chrome Trailer Ball Cover \$11.95



993-181A 678-181

673-823 Saddlebag Reflector Light \$41.95

This light replaces the reflector on the rear and side of each saddlebag and converts them to running lights. Three are required for a complete replacement or replace just the rear reflector or just the saddlebags. Fits the GL1200. Single.

01-194 Replacement 3W Bulb \$.98



01-194

1157R Pathfinder High Performance LED Red Replacement Bulb \$20.00

Direct replacement for the 1157 bulb for applications such as turnsignal. Single filament, 450 lumens. Plug and play. Fits the GL1500. Single.



LED Running and Brake Light Bulb \$19.95

Updates the 1157 bulb on older bikes to make them LED. Dual filament. Special order. Single.



Part	Color
LED-1157RED	Red
LED-1157W	White



LED-1157RED

LED-1157W

673-128 Saddlebag Rock Guards \$76.95

These tri-chrome ABS pieces replace the dull worn out black guards that wrap around the lower front and side of the saddlebags. They provide beauty and protection and make your classic bike look new again. Fits the GL1200. Pair.



Mud Flap Made of sturdy rubber that can take a beating. Comes with or without a light, mounting bracket and the hardware to mount. Mud flap measures 10 inches x 7 inches x 1/4 inches. Fits all GL1500s and most trike fenders. Single.



741-176/3741-176

741-179/3741-179

741-180/3741-180

12-6100RR

45-1227R

091-6211A1G

138-316A1

Part	Description	Price
741-176	Chrome insert with eagle emblem	\$46.95
3741-176	Trike with chrome insert with eagle emblem	\$69.95
741-179	LED red oval light	\$61.95
3741-179	Trike LED red oval light	\$79.95
741-180	LED red rectangle light	\$69.95
3741-180	Trike LED red rectangle light	\$89.95

Part	Replacement	Price
091-6211A1G	Gold Eagle Emblem 3" x 1" - Single	\$7.95
138-316A1	Gold Eagle Emblem 3"x1" - Single	\$6.95
12-6100RR	Oval Red LED 7"x3" - Single	\$14.95
45-1227R	LED Reflector 1 1/4"x 3 1/2" - Single	\$21.95
45-1100	Reflector Grills - Pair	\$14.95

AUDIO



Elite Series Headsets New elite series headsets are top of the line from J&M. The headset comes with hi-intensity mount-in-helmet speakers available in 2 sizes, both 40mm ultra-slim & 45mm large diameter custom, for installation into most motorcycle helmets. The extra hi-output AeroMike® VI are new and are the latest version to provide the very best combination of wind & ambient noise cancellation with an even stronger output signal in the human voice frequency range. The Z-series connection cords are molded using the highest grade copper wire available, together with all stainless steel pins, to provide 5-10 year durability. The UPPER Section cord (only) is included with all elite 787 headsets, allowing the rider to choose the correct lower section hook-up cord applicable to their motorcycle audio system. These will easily connect to all factory audio systems using correct lower cord. Proudly made in the U.S.A. *(**Check availability, some headsets and cords are special order parts.)*



HS-EHI787-LDC-XHO
\$229.99

most open-face & flip-front style helmets



HS-EHI787-UNV-XHO
\$219.99

most open-face, flip-front and full-coverage

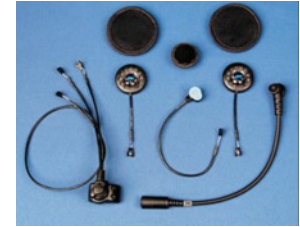

HS-EHI787-FFS-XHO
\$229.99

most full-face helmets



HS-EHI787-HJH-XHO
\$229.99

most HJC/Harley shorty-style (5/8 shell) helmets with slide-in pouches mounting system. **



HS-IHI787-HHU-XHO
\$239.99

most shorty-style (1/2 shell) helmets with slide-in shorty-style mounting system. **



HS-IHI787-N143-XHO
\$229.99

Nolan N103/N90/N91/N86/N43E model **



HS-IHI787-AKO-XHO
\$239.99

Arai Classic/c, SZ/c or KBC TourCom model **

Z Series Lower Section Hook-up Cords for Elite EHI787 Headsets Also fit lower section 8 pin hook-up for Elite 629, 584 series, ECD 374, 271, 5469, 477, 584, JMCB-2003 series.

Part	Fitment	Price
HC-ZB	1980-2016 Honda® and J&M® 5-pin audio systems.	\$79.99
HC-ZB-S	1980-2016 Honda® and J&M® 5-pin audio systems. **	\$109.99
HC-ZBV	1980-2016 Honda® and J&M® 5-pin audio systems	\$119.99
HC-ZC	1983-2014 Yamaha® 5-pin audio systems, 1989-1997 Harley®, Kawasaki® Suzuki® 5-pin audio systems and 1988-2000 Honda® GL-1500 with J&M passenger controller.	\$79.99
HC-ZHD	1998-2016 Harley® 7-pin audio systems **	\$79.99
HC-ZHD-S	1980-2016 Honda® and J&M® 5-pin audio systems **	\$109.99
HC-ZJM	1999-2016 J&M Corp® & BMW® 6-pin audio systems	\$79.99
HC-ZJM-S	1999-2016 J&M® & BMW® 6-pin audio systems **	\$109.99
HC-ZMV	1999-2016 J&M Corp® & BMW® 6-pin audio systems	\$119.99
HC-ZVT	2008-2016 Kawasaki®, Can-Am® Spyder & Victory® Vision 7-pin audio systems **	\$79.99
HC-ZVT-X	2008-2016 Kawasaki®, Can-Am® Spyder & Victory® 7-pin audio systems **	\$119.99
HC-ZAL	8-pin upper-section right-angle hook-up cord	\$49.99



AUDIO



Performance Headsets HS-BCD279, HS-ICD279 and HS-ICD284 series helmet headsets represent J&M's continuing dedication to helmet headset design and performance. Only the finest quality components are used in their manufacture. These headsets provide the industry's best combination of wind and ambient noise reduction with our high-output AeroMike® III miniature microphones. Superior audio fidelity has been achieved with new ultra-slim, wide-fidelity and ported DynaPort® helmet speakers. (exact type will vary depending upon application). The versatility of the convenient two-piece cord system allows these headsets to be connected to any factory installed motorcycle audio system ever built, now and in the foreseeable future, just by interchanging the lower-section hook-up cord. (**Check availability, some headsets and cords are special order parts.)



HS-CD9279-UN-HO
\$114.99

most open-face, flip-front and full-coverage style helmets



HS-CD9279-BMU-HO
\$89.99

most shorty, open-face & flip-front style helmets **



HS-BCD279-UN-HO
\$149.99

most open-face, flip-front and full-coverage style helmets



HS-BCD279-OF-HO
\$169.99

most open-face, and can also be used in some of the flip-front style helmets



HS-BCD279-FF
\$169.99

most full-face style helmets (not flip-up style) **



HS-BCD279-FL-HO
\$169.99

most flip-front and some of the open face (3/4) style helmets with removable cheek pads as part of their interior design



HS-ICD279-KTC-HO
\$179.99

Arai® Classic/c, Classic SZ/c or KBC® TourCom helmets **



HS-BCD284-HJH-HO
\$189.99

HJC/Harley® shorty style with flip-down sunvisor **



HS-ICD284-HHU-HO
\$199.99

most of the shorty-style **

HC-P 8-pin Lower Section Hook-up Cord Used with all J&M® headset #'s HS-ICD284, HS-BCD279, HS-ICD279, HS-CD9279, HS-BCD277, HS-ICD277, HS-BCD257, HS-BCD174, HS-ICD174 and #HS-CD9174 series helmet headsets.

Part	Fitment	Price
HC-PB	1980-2016 Honda® and J&M® 5-pin audio systems	\$29.99
HC-PBT	For connection to the rear jack on the J&M HS-BLU277 series Bluetooth clamp-on helmet headsets	\$24.99
HC-PBV	1980-2016 Honda® and J&M® 5-pin audio systems	\$89.99
HC-PC	1983-2015 Yamaha, 1989-1997 Harley®, Kawasaki®, Suzuki® 5-pin audio systems and 1988-2000 Honda® GL-1500 with J&M passenger controller	\$29.99
HC-PHD	1998-2016 Harley® 7-pin audio systems **	\$29.99
HC-PJM	1999-2016 J&M Corp® & BMW® 6-pin audio systems **	\$29.99
HC-PMV	1999-2016 J&M Corp® 8-pin lower-section hook-up cord with in-line volume control & BMW® 6-pin audio Systems **	\$89.99
HC-PVT	2008-2016 Kawasaki®, 08-14 Can-Am® Spyder & Victory® Vision 7-pin audio systems **	\$29.99
HC-PA	Straight 8-pin upper-section hook-up cord- included with J&M® headset HS-CD9279 and HS-CD9174	\$27.99
HC-PAL	Right angle J&M® headset HS-ICD279, HS-BCD279, HS-BCD277, HS-ICD277, HS-BCD257, HS-BCD174 and HS-ICD174	\$27.99

AUDIO



Nolan Performance Headsets The J&M high performance custom integrated headsets feature miniature high-output (XHO-HO) AeroMike® boom microphones, (tuned for use with all factory installed motorcycle audio systems), new high-intensity helmet speakers for improved on-highway audio performance, along with the 8-pin two-piece P hook-up cord system (upper cord ONLY included with headset). This allows connection of these headsets to any factory installed motorcycle audio system in existence today, including the new 2014-2015 Harley Infotainment systems & Honda GL1800 Premium Audio, just by interchanging the lower section P hook-up cord. Choose between the new top-of-the line Elite 787 series or the performance 279 series integrated headsets.

HC-E Single-Section 5-pin Cord \$69.99

J&M Replacement Single-Section 5-pin Cord 1988-2015 Hondaline Headsets



HC-E

HC-JJ Single-Section 5-pin Cord \$29.99

Replacement single-section 5-pin hook-up cord for J&M headsets #HS-8154, HS-8134, HS-8146, HS-8169, or HS-8129.



HC-JJ



HS-ICD279-N102-HO
\$179.99

N-102 N-Com helmet ONLY, (NOT std N102 or N103)



HS-ICD279-N143-HO
\$179.99

N103, N90, N91, N86, N43 or N43E Trilogy helmets

J&M's Bluetooth Headsets The audio performance will rival that of the best corded headsets. Unit features the CSR BluecoreV enhanced data rate (EDR) Bluetooth module, for easy pairing to most Bluetooth enabled audio devices; Smartphone, Cell-Phone, Bluetooth enabled GPS, MP3, iPod music devices etc, along with custom dongles for connection to certain portable FRS radios. Multifunctional software package includes an embedded FM stereo receiver, standard Bluetooth profiles of HSP, (Headset Profile) HFP, (Hands Free Profile), A2DP (Advanced Audio Distribution Profile) & AVRCP (Audio/Video Remote Control Profile), along with the J&M exclusive helmet to helmet intercom profile. Up to 3 headsets can be paired together at distances of up to 500 meters. (An unlimited number of bike-to-bike intercom connections are available, at distances of up to 1.5 miles, when headsets are linked to Bluetooth enabled FRS portable radios). Built-in 3.5 mm stereo output jack. Uses rechargeable Lithium Ion/Polymer power cell providing 9-13 hours of use from a full charge.

Any technical questions regarding J&M parts can be called directly to J&M 1-800-358-0881. All returns direct to J&M.

All J&M Bluetooth sales are FINAL. All are special orders.

CGBH-GL18 Bluehub Bluetooth Cell/Smart phone/GPS /RadarBeep Terminal \$699.99



NEW Custom made and totally new J&M BluHub® Bluetooth terminal will integrate a Cell-Phone, Smart-Phone, Bluetooth enabled GPS unit and/or specific Radar-Detectors with the driver's (only) J&M or Honda brand corded helmet headset. A totally plug-n-play Bluetooth cell-phone integration solution for all years of the Honda GL1800 or F6B.



Replacement Headset Pigtail This replacement headset pigtail comes in handy when one of the factory units wears out and is applicable for all years of the Honda GL1500 and GL1800/F6B. Direct plug in with no modifications, it uses a heavy-duty female headset plug. Dust cover included.



HSPT-GL15 \$39.99
HSPT-GL18 \$34.99

Deluxe Passenger Controller \$199.99

By J&M®. A passenger controller provides an easy to use passenger headset volume control, a large CB radio PTT button, and a passenger microphone on/off switch. (bike does NOT need to have a CB radio installed to utilize the features of this controller.) Mounts to the right inside side seat grab rail. Connects into the stock wiring harnesses under the seat. Single.



PSCR-GL1500 for GL1500
PSCR-GL1800 for GL1800

AUDIO



JMDM-GL18E Digital Music Player USB/Aux/Bluetooth® for 2001-2010 GL-1800 CD Input \$179.99

Digital music player from J&M will plug directly into the CD selected music input plug on all 2001-2010 Honda Gold Wing audio systems, replacing the Honda CD changer, at a fraction of the cost. Store and play up to 550 MP3 song tracks (MP3, WMA or WAV) on a single USB Thumb drive, and toggle thru songs on existing handlebar audio system controls. Link by Bluetooth® your smartphone or Garmin® Zumo to the player and your smartphone stereo media or navigation commands will stream and automatically prioritize OVER whichever music files are being played from the USB Thumb drive at the time. Direct under-seat plug-n-play harness Note: If you wish to use the XM satellite radio feature of your audio system, with this digital music changer, you will need J&M part JMDM-ADT-GL18.



JMDM-GL18E

JMDM-ADT-GL18 XM-Sat/Digital Music Adapter/Switch Kit 2009-2010 GL1800 \$99.99

For model years 2009-2010 GL1800, if you wish to use the XM satellite radio feature of your audio system, in conjunction with the JMDM-IPBT-GL18, JMDM-IPAX-GL18, or JMDM-GL18 digital music changer, use this adapter harness/switch kit. This harness kit will allow you to switch back and forth between XM satellite radio and the J&M digital music player/changers, without the two audio sources mixing together. Simple plug-n-play installation.



JMDM-ADT-GL18

JMDM-IPBT-JCB03 Digital Music/iPod/Bluetooth Player JMCB-2003E/K for -B w/adapt \$299.99

Stream music videos down off of You-Tube with your favorite Smartphone, also stream stereo music down off of Pandora and/or your SmartPhones's own internal music files, and direct them by Bluetooth into the JMCB-2003, thru J&M's Bluetooth enabled digital music controller. A Smartphone or Garmin Zumo can also be linked by Bluetooth to the J&M music controller, while an iPod is simultaneously connected by wire, and when a navigation command or cell phone call is received, it will automatically interrupt the iPod music signal into the system. When initiating or answering a cell phone call on-screen, the rider and/or passenger can talk over the cell phone using the very same J&M corded headsets already connected to the JMCB-2003, that are normally used for CB and intercom functions. This digital music controller is designed to plug right in to the JMCB-2003E/K models and will also work with the earlier JMCB-2003B model systems, with the #JMDM-ADT-JCB03 adapter, as an extra cost item. This controller wiring harness also provides for direct plug-n-play of the custom J&M CFRG type radar detector adapter harnesses, (extra cost item) for automatic radar beep alert into one headset speaker, along with a power/ground source connection for a Garmin Zumo. This digital music controller Bluetooth/Smartphone/iPod kit includes all direct plug-n-play harnesses for the JMCB-2003E/K audio system, wired extension cable for iPod, 3.5mm aux extension cable, and a complete installation, operation & easy to use Bluetooth linking instruction manual. Important Note: This J&M digital music player with Bluetooth is NOT completely weather resistant, much like cell phone, so it is important during the installation that the unit control head be mounted & stored in some type of compartment or pouch on the motorcycle, so that it is not exposed to significant amounts of moisture, as water damage is not covered under the warranty for this item.



JMDM-IPBT-JCB03

a

JMDM-ADT-JCB03 Adapter Harness for Connecting JMDM-IPBT-JCB03 to JMCB-2003B Models

This simple plug-n-play adapter cable will connect the new #JMDM-IPBT-JCB03 digital music/iPod/Bluetooth player to the early model JMCB-2003 and JMCB-2003B audio systems.



JMDM-ADT-JCB03

CBHM-GL1815 CB Hand Mike Kit \$129.99

This CB hand microphone kit is for the 1988-2016 Honda Gold Wing GL1800 or GL1500. Once installed, the included female headset pig-tail jack with dust-cover, will accept either this specific J&M CB hand mike, or the standard 5-pin lower cord connection from a J&M, Honda or other brand compatible helmet headset. Comes with black powder coated, stainless steel handlebar mounting bracket & mounting hardware, with heavy-duty mike clip. Has plug-n-play wiring harnesses compatible with all years of the GL1800 or GL1500.



AUDIO



JMCB-2003 — The world's first, all-in-one, handlebar-mounted, motorcycle audio system!

Features a 40 channel CB radio, NOAA weather band, rider/passenger intercom and stereo music amplification from any portable/MP3-type/I-pod music device. Mount it to your left handlebar with the proper **bracket kit**, connect the headset/power harness to your bike's electrical system, (choose between **solo or rider/passenger kits**) install the **license plate mounted CB antenna**, (or any other properly tuned CB antenna) plug in your favorite **J&M dual-mode helmet headset/headsets** and you are ready to go. **Special Order**

Important Note: The JMCB-2003 is a J&M 6-pin audio system that requires the pre-amplified microphone signal provided by Dual-Mode (ECD/ICD/BCD/CD prefixed) helmet headsets along with the **HC-ZJM** or **HC-PJM** lower section hook-up cord.

Stereo Music/CB /Weather Radio Audio Sys Solo Operation

Kit includes the JMCB-2003K radio head unit, new deluxe solo headset hook-up harness (for one headset only), switchable power supply/noise filter, weather cover, cable tie straps, hardware and a complete installation and operation manual.

Part	Type	Price
JMCB-2003K-SL	Solo	\$429.99
JMCB-2003K-DU	Driver and Passenger	\$499.99



Mounting Bracket \$59.99

- JCB03-HBK01** Honda Valkyrie/St-1300/1100
- JCB03-HBK01P** polished most Honda Cruisers
- JCB03-HBK02** Harley
- JCB03-HBK02P** Harley polished
- JCB03-HBK02-14** Harley polished 2014
- JCB03-HBK03** Yamaha
- JCB03-HBK03S** Yamaha Stratoliner
- JCB03-HBK04** Suzuki
- JCB03-HBK05** Kawasaki
- JCB03-HBK07** Victory



License Plate Mount CB Antenna Kit \$99.99

This kit includes a black powder coated mounting bracket, a top-loaded antenna staff with dust cover, mounting stud, frame attachment grounding strap, antenna connection cable, cable ties, mounting hardware and complete installation instructions.

- LPCBA-100** 1 Foot
- LPCBA-200** 2 Foot
- LPCBA-300** 3 Foot
- LPCBA-400** 4 Foot

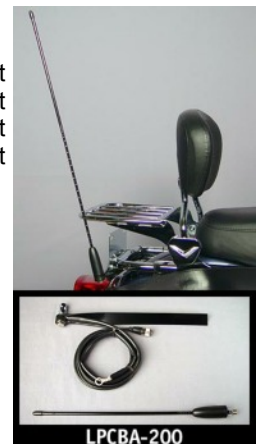

Microphone Windsocks Black foam windsocks are a very easy and inexpensive way to keep your windssock fresh by replacing weather worn or dirty ones. Single.



Part	Description	Price
45-6912B	Large	\$1.95
45-6909BS	Mini Aero Black	\$1.95
45-6902B	Black Standard ½ " hole	\$1.95
45-6902E	Teal Standard ½ " hole	\$1.95
45-6902R	Red Standard ½ " hole	\$1.95

Microphone Windsocks J&M Black Microphone Windsocks. Dense foam to protect the microphone.

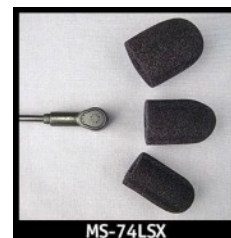

Part	Size- Qty	Price
MS-57LSB	1 Large ¾ ", 1 Small	\$8.99
MS-2BL	2 Standard ½ "	\$6.99
MS-74LSX	1 Mini Aero ¼ ", 1 large ¾ ", 1 XL	\$12.99

AUDIO



18673-629 GL1800 CB Antenna \$109.95

This CB radio antenna attaches to the trunk in the same manner as the OEM radio antenna. It has a spring loaded fold down feature, was designed not to wobble, has an angle adjustment stop and includes a ground strap and mounting hardware. Fits the GL1800. Single.



15673-629 GL1500 CB Antenna \$109.95

CB radio antenna works on all the GL1500's and comes complete with all the mounting hardware. Has a fold down feature to make it easier to store the bike or cover. Single.



673-629 GL1100-GL1200 Type 3 Radio/CB Antenna \$49.95

This is a quality OEM replacement type 3 radio and CB antenna and can be used on both sides of the bike. Fits the GL1100 and GL1200. Single.



45-1810EU GL1800 FM/Satellite Radio Antenna Tip \$34.95

The antenna helps to eliminate FM interference when traveling through high FM output areas. It has a fold down feature to help when stowing the bike. Measures 16 inches. Single.

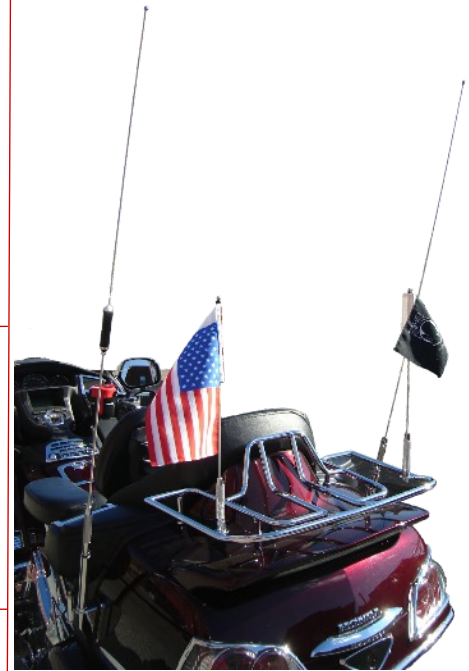

Replacement Antenna Parts Single parts

Part	Description	Fitment	Price
18673-629AA	CB Antenna Tip	GL1800 GL1500	\$5.95
45-1810-A/D	CB Staff & Tip- after-market screw style	GL1800 GL1500	\$47.95
673-629AA	CB Antenna Tip	GL1100 GL1200	\$9.95
45-1810-P	Swivel Pin	GL1800 GL1500	\$4.95
45-1810-S	Set Screw	GL1800 GL1500	\$3.95



424-062A Antenna Relocation Bracket \$7.95

Moves the antenna down and out of the way when adding a light bar. Fit GL1100 and GL1200.



45-1810B Top Tube Accent \$9.95

Tri-chromed accent fits over the CB antenna and sits on top of the base for a smooth chrome finish at the base of the antenna. Fits on Add On part 18673-629 CB antenna. Fits the GL1800. Single.



AUDIO



Speakers and Kits They are a great value and provide the volume and sound quality you can expect. Pair.

Part	Description	Size	Price
FSPU-GL06-XT J&M	GL1800/F6B 06-16 Fairing, 3.8 ohms 140 watts	6 Inch	\$159.99
FRSU-GL1518 J&M	GL1800 01-05 Fairing & 01-16 Rear, GL1500 Fairing, Euro Fairing 88-16, 3.8 ohms 120W	5 inch	\$99.99
RSPK-GL18 J&M	GL1800 01-05 Rear Speaker Kit w/Wire Harness, 3 ohms 120W	5 inch	\$119.99
18678-824	GL1800 01-05 Rear Speaker Kit w/Wire Harness 35W	5 inch	\$65.95
15678-824	GL1500 Rear Speaker Kit w/Wire Harness (not Interstate) 25W 4 ohms	4 inch	\$54.95
678-824	GL1100, GL1200 Fairing, GL1500 Fairing & Rear 25W 4 ohms	4 inch	\$26.95
45-1801-2/3	GL1800 01-05 Rear Speaker Wire Harness		\$27.95
15678-824W	GL1500 Rear Speaker Wire Harness w/Fader Switch		\$30.95

FSPU-GL06-XT



RSPK-GL18

FRSU-GL1518



678-824

18678-824



45-1801-2/3

15678-824



15678-824W

HRDW-2719 Replacement Headset Hardware Kit \$14.99

Replacement Hardware kit for most J&M Corded Helmet Head sets.



HRDW-2719

HV-800 Helmet Visor \$11.99

By J&M®. This black visor has a smooth contoured look. The 3 snap mounting is invisible making the helmet have a custom look.

This is a rugged piece that will hold up in all conditions. Single.



IRC871 Radio Bezel \$41.95

The radio bezel has a universal fit to work on most aftermarket radios. Drilling is required to mount and hardware is included. Measurements are: 11 7/8 inches L x 2 7/16 inches W x 1 9/16 inches H; radio opening 7 3/16 inches L x 2 1/8 inches W; and center hole to center hole is 1 11/16 inches for drilling. Fits the GL1200 Interstates or radio fitting these dimensions. Single.



428-124H Super Seer Ears \$26.95

By Seer, made in the U.S.A. Black ABS speaker holders attach to half helmets with Velcro. Eliminates the need to use the neck warmer to hold the speakers in place. Pair.



APPAREL/NOVELTY



Bike Snow Globe \$21.95

Great for the holidays, birthdays, special events or just because, these snow globes will make a great gift. The GL1500 bike is a two tone, gold and silver with white confetti. The GL1800 trike is gold tone with clear silver confetti. They are wonderfully detailed in an antiqued finish, making them unique and very special. Each globe sits on top of a round black resin base with a flat surface which is perfect for mounting a plaque if desired (not included) and making your gift giving even more meaningful. Measures approximately 5 inches tall, 4" wide. Single.



Part	Description
RSG-200	GL1800 Trike
RSG-300	GL1500 Bike

678-024-20 Trike Belt Buckle \$24.95

Limited edition pewter belt buckle has beautifully raised designs showing great detail of a trike. Every collector should have one. Measures 3 1/2 inches x 2 1/2 inches. Single.



CH-1 Chrome Nuts \$5.95

This is a unique little fun novelty. The chrome nuts come with a fun story about "chrome depression". "...By taking one or more ... you will be able to buy more chrome...with fewer side effects." These nuts are silver candy coated almonds. 10 Pack.



Motorcycle Pins The gorgeous pins can be used on hats, vest, shirts, or anything else. All have double pin backs. Single.

Part	Description	Price
091-6212G	GL1500 Trike gold tone 1 3/4" x 1 1/4"	\$10.95
091-6214G	GL1800 Trike gold tone 2" x 1"	\$10.95
45-1098G	Tour Bike gold tone 2" x 1"	\$7.95
45-1098S	Tour Bike silver tone 2" x 1"	\$7.95



NEW "Winging the World" T-Shirt

A great shirt to let people know how much you love riding your bike. The shirt is red with white and blue lettering. The blue and white globe represents all the Goldwing riders who travel around this amazing world. Single.



Back Design

Part	Size	Price
5001	Medium	\$19.95
5002	Large	\$19.95
5003	X-Large	\$19.95
5004	XX-Large	\$21.95
5005	XXX-Large	\$22.95

"Save Gas Ride A Motorcycle" T-shirt

A great shirt to let people know that riding your bike saves on gas and money. The shirt is dark blue with red and white lettering. Single.



Part	Size	Price
3012	Medium	\$14.95
3013	Large	\$14.95
3016	XXX-Large	\$19.95

4017 Trike Hat \$19.95

The washed cotton tan hat is embroidered with a red, black and silver trike. It has a washed blue brim and adjustable cloth strap with a brass snap closure. The design is on the front of the cap only. One size fits most. Single.



PL12 Pin Lok \$8.95

Barrel-shaped chromed steel holders slip over the pin studs and set screws to lock it in place. Never worry about losing your pins. Each package contains 12 pin backs, 12 set screws and 1 wrench.



ELECTRICAL



Universal Accessory Switch Kits Combines lighted accessory switch, LCD voltmeter and a chrome plate in various combinations. Each will work on any flat surface of a bike and will require drilling for installation. Add more accessories and monitor battery condition at the same time. All kits include a wire harness and lighted switches. The voltmeter has a lighted readout, is light-weight and waterproof. Tri-chromed ABS panels are self-adhesive.

18187 Accessory Switch Kit \$24.95

Four lighted switches and wire harness.



18188 Digital Voltmeter and Accessory Switches \$45.95

Voltmeter, three lighted switches and wire harness.



18189 Accessory Switches and Chrome Panel \$45.95

Four lighted switches, chrome panel, wire harness.



18190 Digital Voltmeter, Accessory Switches and Chrome Panel \$65.95

Voltmeter, three lighted switches, chrome panel, wire harness.



Replacement Parts for Accessory Switch Kits

Part	Description	Price
673-187G	Green Lighted Rocker Switch	\$4.95
673-187R	Red Lighted Rocker Switch	\$2.95
45-1405	Digital Voltmeter 1"x1½"	\$29.95
45-1215-1	Chrome Plate 4 Switches	\$19.95
45-1215-2	Chrome Plate 3 Switches & Meter	\$19.95



673-187G



673-187R



45-1215-1



45-1405



45-1215-2

132-1800 Cigarette Lighter/Accessory Socket \$15.95

The chrome cigarette lighter plugs into the existing wire harness on the GL1800 and includes a 10 amp fuse. When not in use as a lighter, it can be an extra accessory socket for your electronic devices. For older model bikes, this unit can be directly wired into the bike. Drilling is required. Single.



01-771 Mini Fuse Kit \$5.25

The kit contains 5 fuses to handle most unexpected situations while on the road. Set includes one each of 5, 10, 15, 20, and 30 amp fuses. Easy storage. 5 Pack.



45-1299-W Wire Connector \$6.95

This easy to use wire connector provides a convenient way to splice or tap two wires together. Wires hold together by placing them in the connector and snapping it closed, keeping them securely fastened. Made for 22-26 gauge wires. Perfect for the do it yourself kind of person. 10 packs.



V520-10 Universal Driving Light Wire Kit \$21.95

This is a universal 12 volt light switch kit which includes a relay, fuse, wire and switch. Ideal for many types of light applications on the bike, trike or trailer. Single.



Electrical Terminal Couplers. Electrical terminal couplers are OEM quality and a necessity to any garage mechanic. 10 Pack.

45-8132-A \$11.95
Female/Male Nylon Connector with Brass Terminal for 3 Wires



45-8132-B \$10.95
Female/Male Nylon Connector with Brass Terminal for 2 Wires



ELECTRICAL



Battery Tender Battery chargers will charge and maintain any acid or gel battery. Red light shows charging and switches to green when maintaining the charge. Includes a permanent mounted hookup cord and quick disconnect alligator clips.

BC-2 Battery Tender Junior \$39.95

Compact, 12V/1.75amp output. Great for traveling. 3.3" x 2.3" x 1.9"



081-0069-4 Replacement Alligator Clips \$9.95

081-0069-6 Replacement Quick Disconnect \$9.95



BC-4 Battery Tender \$69.95

12V/1.25 amps. Maintain the battery at 13.2V, so you are always ready to ride.



Horn Cover Chromed steel horn cover.

Part	Description	Price
673-134	GL1000, 1100, 1200. Pairs.	\$31.95
673-134A	Valkyrie Single	\$15.95



84-96308 Jumper Cables \$17.95

Jumper cable is 8 feet in length and has a rubberized coating and insulated clamps. Single.



86-18122 Universal 12V Horn \$19.95

The chrome universal 12 volt horn is made of steel and has 105 decibels of sound. It has a mounting plate attached for easy installation on any bike, trike or any 12 volt system. Single.



Bad Boy Air Horns By Wolo, this one-piece design air horn requires no air hoses and installs in minutes by simply transferring the factory horn wires to the compressor. Produces a powerful dual tone air horn sound that is two times louder than the factory horn. The BAD BOY is compact in size and works on any 12-volt system.

Part	Description	Price
419	Black, 118 Decibels- 530/680 HZ. 2 1/2" x 4 1/2" x 4 1/2"	\$59.95
519	Chrome, 118 Decibels- 530/680 HZ. 2 1/2" x 4 1/2" x 4 1/2"	\$79.95
619	Black, 123.5 Decibels- 320 HZ. 5 3/4" x 3 1/2" x 4 5/8"	\$80.95
719	Chrome, 123.5 Decibels- 320 HZ. 5 3/4" x 3 1/2" x 4 5/8"	\$89.95



403 Air Max Chromed Plastic Horns \$49.95

By Wolo, these chrome ABS air horns are perfect for any 12 volt system. Kit has 2 durable plastic trumpets with a bright chrome plated finish, a chrome plated compact maintenance free compressor, and mounting hardware to easily install on any bike. 120 Decibels-620/740 Hz. Pair.



415-MCDTK Air Splitter \$167.95

By Wolo, these air powered horns are super loud and have the options of a two tone alternating blast or one steady blast. Works on any 12 volt system. Consists of 2 chrome metal trumpets with the longest being 8 1/2 inches, air compressor and mounting hardware. 120 Decibels-512/625 Hz. Pair.



45-6103 Chrome End Cap \$4.95

The chromed ABS cap fits over the end of all Wolo air horns and gives the horns a nice complete chrome finish. Measures 2 1/2 inches in diameter. Single.



415WPC Weather Protection Cap \$12.95

By Wolo. Chrome plated plastic cover is ideal for protecting Wolo air horn trumpets from rain, snow, dirt, etc. Universal fit for all Wolo air horn trumpets. Single.



415WK Horn Installation Kit \$14.95

Wiring kit for the WOLO air horns comes complete with 30 amp fuse, 1/4 inch spades, butt connectors, ground eyes, 10 feet of 12 gauge wire and wire ties.



EMBLEMS/TRIM



LED Lighted Eagle Emblem This unique modern looking eagle has 14 super bright amber LED lights and works as a running and turn signal light. The eagle has a slight curve to fit on many surfaces such as the windshield panel or trunk and uses self-adhesive tape to mount. Measures 7 inches x 2 inches. Single.

Part	Description	Price
45-1240LED	Chrome with amber light	\$69.95
45-1240RLED	Chrome with red light	\$69.95
45-1240GLED	Gold with amber light	\$79.95



45-1240LED



45-1240RLED



45-1240GLED



Gold Eagle Emblem Updated flying eagle emblem with self adhesive tape. Remove protective film to reveal the beautiful gold tone. Single.

Part	Size	Price
091-6211A1G	3" x 1"	\$7.95
091-6211A3G	1 3/4" x 1/2"	\$4.95
091-6211A4G	3/4" x 1/4"	\$3.95



091-6211A1G



091-6211A3G



091-6211A4G



15138-394 Gold Flying Eagle \$19.95

This is a classic gold tone flying eagle design. Fits on any slightly curved surface such as the GL1500 windshield panel. Measures 7 inches wing tip to wing tip. Single.



138-394A Gold Flying Eagles \$20.95

This is a classic flying eagle design that comes as a left and right pair. Fits on any flat surface and each measures 4 1/2 inches. Pair.



Gold Eagle with Red Shield Classic eagle design. Single.

Part	Size	Price
138-316	3/4" x 1/4"	\$3.95
138-316A	4" x 2 1/2"	\$7.95
138-316A1	3" x 1"	\$6.95
138-316A2	2 1/2" x 3/4"	\$6.95
138-316A3	1 3/4" x 1/2"	\$4.95



138-316A1



138-316A2



138-316A



138-316



138-316A3

Eagle Trims Chrome ABS eagle emblem is an attractive accent which has an eagle head and wing design. The eagle is made with a slight curve allowing it to fit in a variety of places on bikes, trikes or trailers. Easy to install with self-adhesive tape. Pair.

Part	Description	Price
45-1837	10 inches with "1800" engraved in black on the side.	\$51.95
45-1839	7 inches	\$43.95



45-1837



45-1839

13-7913CR Eagle Krommets \$15.95

Eagle head krommets come with 1/4-20 thread ends. A great accent piece that can be used in many applications such as the license plate. Pairs.



EMBLEMS/TRIM

Gold Flying Eagle with USA Flags

This very popular emblem has a gold flying eagle over two USA flags. Fits on any flat surface and uses self-adhesive tape to mount. Great for adding anywhere onto the bike, trike or trailer. Single.

Part	Size	Price
91-6207G	4 1/4" x 2 3/4"	\$14.95
91-6208G	3" x 1 3/4"	\$13.95



Chrome Eagle Decal \$9.95

The chrome round disc measures 2 3/4 inches in diameter and is embossed with an eagle. Uses self adhesive tape to mount on any flat surface on any bike, trike or trailer and is a perfect fit for the front or rear on the Can Am®. Single.

Part	Color Eagle
46-1002	Gold
46-1002B	Black



46-1002



46-1002B



07-83261 Indian Head Fender Light \$51.95

A classic fender light includes rubber gasket for screw mount. Measures 7 3/4 inches x 2 3/4 inches. Single.



678-116 Chrome Pin Striping \$12.95

This chrome trim creates additional chrome accents anywhere on a bike, trike or trailer. Comes in a 20 foot roll and can be cut to size. Measures 1/4 inch wide with one side rounded and the other side flat and uses self-adhesive tape to mount. Single.



678-118 Windshield Trim \$19.95

The chrome trim fits on the edge of the windshield to add a nice touch of chrome to the front of the bike or trike. It has universal uses for chrome edging. Measures 1/4 inch in width, has an opening so it can slip over edges and comes in a 20 foot roll that can be cut to meet desired lengths required. Single.



Wing Emblem with USA Crest \$7.95

This emblem has wings with a USA shield in the center. Fits any flat surface. Measures 3 inches x 7/8 inch. Single.

Part	Color
091-6210C	Chrome
091-6210G	Gold



091-6210C



091-6210G

91-6203A SE Gold Emblem \$11.95

The gold tone emblem "SE" will make any bike, trike or trailer special. Mounts with self-adhesive tape. Measures 2 1/4 inches x 3/4 inches. Single.



252-211 Chrome Bullets \$19.95

The chrome bullets come with a 1/4-20 thread and can be used to add a unique accent to license plates and other areas of the bike, trike or trailer. 10 pack.



45-1231 Chrome LED Lighted Eagle Ornament \$43.95

A redesigned front fender ornament with LEDs to light the eyes and front of the eagle. The eagle has smoother lines and more pronounced features. Fits all GL1800s and many other large curved fenders. Measures 6 1/2 inches, front 1 3/8 inches, back 4 1/2 inches. Single.



342-137L Lighted Front Fender Eagle \$34.95

Classic eagle with red eyes includes rubber gasket for screw mount. 6 3/4 inches x 1 1/4 inch. Single.



S37734 Body Molding \$36.95

A great way to add some nice chrome accents to give the bike, trike or trailer a uniquely creative look. Comes in a 12 foot roll measuring 3/4 inch wide. The trim can be cut to size and installs with self adhesive tape. Single.



T3605C Wheel Well Trim \$29.95

A great way to add some nice chrome accents to give the bike, trike or trailer a uniquely creative look. Comes in a 18 foot roll measuring 3/8 inch wide. It can be cut to size and installs with self adhesive tape. Single.



FLAGPOLE KITS



Adjustable Flagpole Set \$49.95

Each set includes a flagpole, adjustable fold down base, a chrome die cast eagle or a 5/8" chrome ball, and a 2 piece pole clamp.

Part	Description
678-015	8" with eagle
678-015B	8" with ball
678-016	12" with eagle
678-016B	12" with ball

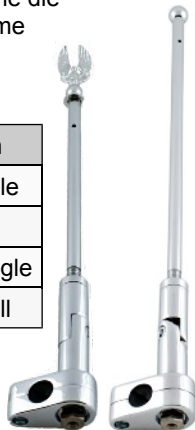

Ultimate Flag Pole Set \$31.95

Each set includes a flagpole, a chrome die cast eagle or a 5/8" chrome ball, and a 2 piece pole clamp.

Part	Description
678-014	8" with eagle
678-014B	8" with ball
678-018	12" with eagle
678-018B	12" with ball

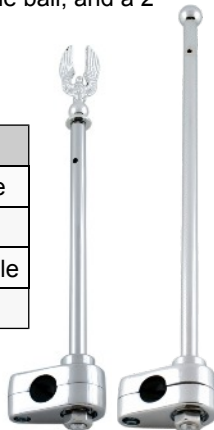

Flat Clamp Flagpole Set \$41.95

Each set includes a flagpole, a chrome die cast eagle or a 5/8" chrome ball, and a 2 piece flat pole clamp.

Part	Description
678-012	8" with eagle
678-012B	8" with ball
678-013	12" with eagle
678-013B	12" with ball

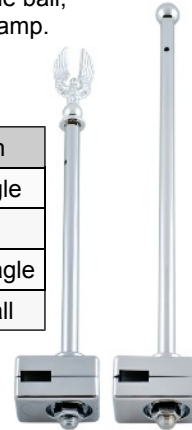

Flat Clamp Adjustable Flagpole Set \$49.95

Each set includes a flagpole, an adjustable fold down base, a chrome die cast eagle or a 5/8" chrome ball, and a 2 piece flat pole clamp.

Part	Description
678-010	8" with eagle
678-010B	8" with ball
678-011	12" with eagle
678-011B	12" with ball



Flagpole Set \$29.95

Each set includes a flagpole, a chrome die cast eagle or a 5/8" chrome ball, and a chrome mini clamp.

Part	Description
678-020-8	8" with eagle
678-020-8B	8" with ball
678-020	12" with eagle
678-020B	12" with ball

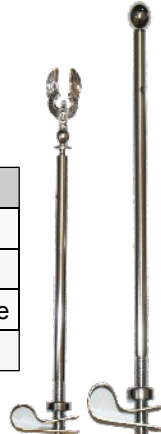

JD's Flagpole Set \$49.95

The flag pole kit consists of a 12 inch, 4 mm stainless steel pole with a small ball on the end, mounted on a chrome spring loaded fold down base with a round pole clamp or a flat pole clamp.

Part	Description
678-008	with round clamp
678-009	with flat clamp

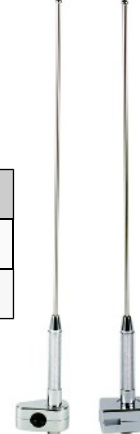

Flagpole Accessories

Part	Description - Single	Price
45-6906-B	Chrome Ball, 5/8" 1/4"-20 Stud	\$7.95
678-018E	Chrome Eagle, 2 3/8" 1/4"-20 Stud	\$1.95
AE05G	Gold Eagle, 3 1/2" 1/4"-20 Stud	\$5.95
AE10G	Gold Eagle, 2 5/8" 1/4"-20 Stud	\$3.95
AE20G	Gold Eagle, 2 3/8" 1/4"-20 Stud	\$2.95
9036	USA Antenna Flag, 4" x6"	\$4.95
9036S	USA Flagpole Flag, 9 3/4" x 5 3/4"	\$7.95
678-017	Chrome Flagpole, 12"	\$14.95
678-019	Chrome Flagpole, 8"	\$14.95
45-6907	Chrome Fold Down Base 2 1/2" 3/8"-16 thread	\$13.95
998-136	Chrome Mini Clamp, fits a 5/8" rail	\$5.95
998-138	Chrome Pole Clamp, fits a 1/2" or 5/8" rail	\$11.95
77-6037	Chrome Flat Clamp, fits most flat rail trunk racks	\$21.95



FOOTRESTS



18548A Adjustable Highway Pegs \$218.95

This highway peg set has die cast and chromed plated pegs and chrome mounting arms. The mounting arm has 7 possible positions for adjustment to meet the rider's comfort and will work on any 1 inch bar. They can fold up to move out of the way when not in use. Each set includes chrome mounting brackets to attach to the horizontal part of the case guards, chrome and rubber buffalo pegs and chrome clamps. Fits the GL1800 or bike with a 1 inch bar. Pair.



18548C Adjustable Driver Boards \$319.95

This highway board set has die cast chromed boards with rubber inlay and chrome mounting arms. The mounting arm has 7 possible positions for adjustment to meet the rider's comfort and will work on any 1 inch bar. They can fold up to move out of the way when not in use. Each set includes chrome mounting brackets to attach to the horizontal part of the case guards, chrome and rubber boards and chrome 3 piece clamps. Fits the GL1800 or bike with a 1 inch bar. Pair.



18548D Adjustable Comfort Pegs with Heel Rests \$269.95

These are die cast and chromed plated comfort pegs with heel rest. They fold up to move out of the way when not in use. Each set includes chrome mounting brackets to attach to the horizontal part of the case guards. The mounting arm has 7 possible positions for adjustment to meet the rider's comfort, includes chrome 3 piece clamps. Fits the GL1800 or bike with a 1 inch bar. Pair.



P77-6003B Custom Adjustable Highway Pegs with Buffalo Pegs \$109.95

These tri chromed billet custom clamps are beautiful and functional. This set comes with adjustable Buffalo pegs and will work on any 1 inch bar. Economically priced. Pair.



P77-6003 Custom Adjustable Highway Clamps \$79.95

These tri chromed billet custom clamps are beautiful and functional. They will work with a variety of difference pegs on any 1 inch bar. Economically priced. Pair.



17-0637JIR Replacement Heel Rubber \$5.95 Pair.



P77-6003C Custom Adjustable Highway Pegs with Buffalo Peg and Heel Rests \$155.95

These tri chromed billet custom clamps are beautiful and functional. This set comes with adjustable Buffalo pegs, with heel rest, and will work on any 1 inch bar. Economically priced. Pair.



Comfort Peg with Heel Rest and Clamps \$149.95

This complete tri-chromed peg set includes pegs with heel rest and raised rubber inserts, clevis and chrome 3 piece clamps to attach to engine guards. Great for added riding comfort. Pair.



17-0637JI Comfort Peg with Heel Rest \$75.95

These are tri-chromed pegs with heel rest and raised rubber inserts. They work with a variety of mounting hardware to attach to the bike such as Add On part 39-1536B clevis and any 1 inch clamps. Each sold separately or as a kit. An Allen wrench is include to mount pegs. Pair.



Part	Description
17-0637JIG	Fits 1" bar
17-0637JIH	Fits 1 1/4" bar
17-0637JIV	Fits 1 1/8" bar



FOOTRESTS



45-1613 Adjustable Mount \$169.95

These beautiful chrome adjustable peg mounts work on any 1 inch bar. They are adjustable to 7 positions to meet the rider's comfort needs. Includes mount, clamp and clevis. Used on Add On parts 18548A adjustable highway pegs, 18548C adjustable highway boards, 18548D adjustable highway peg with heel rest. Pair.



18393-545B Brake Pedal \$89.95

This chrome driver floorboard brake pedal with black rubber pad is larger for added comfort while using. Drilling is required for a screw mount application. Used on Add On part 18393-545 GL1800 driver floorboards. Fits all Goldwing GL1800s. Single.



45-8720 Shifter Pad Replacement \$9.95

A tri-chromed replacement driver floorboard shifter pad has a black rubber insert. The pad also has universal applications with a screw mount. Single.



38-1131 Shifter Peg \$9.95

The universal chrome shifter peg has 3 black rubber inlays. Replacement peg for Add On parts 15393-545A1, Driver Floorboards, 18393-545, GL1800 Driver Floorboards and 45-1620 and 45-1620A GL1800 Driver Boards with shifter. Single.



39-14231 Large Buffalo Pegs \$49.95

These universal chrome pegs with rubber inserts have a male end. Allen wrench included. Pair.



Buffalo Comfort Pegs \$95.95

Make your ride more comfortable with this peg set. The set includes a pair of chrome buffalo pegs with 4 raised rubber inserts, a pair of chrome 3 piece clamps, a pair of chrome clevis and an Allen wrench. Pegs fold up and out of the way when not in use. Fits on the case guard bar. Pair.

Part	Description
39-1536G	Fits 1" bar
39-1536H	Fits 1 1/4" bar
39-1536V	Fits 1 1/8" bar



39-1536I Small Peg \$35.95

These universal chrome pegs with rubber inserts have a male end. Allen wrench included.



38-1131-R Replacement Rubber Ring \$2.95

Replacement rubber for a shifter peg. Single.



Three Piece Clamps \$17.95

The tri-chromed 3 piece clamp is a universal clamp used for mounting boards, pegs or lights. Single.

Part	Size
998-128	1 Inch bar
998-129	1 1/4 inch bar
998-130	1 1/8 inch bar



39-1536B Foot Peg Mount \$19.95

The tri-chromed clevis fits any male foot peg and boards to allow them to fold up. It is a 1/2-20 thread clevis and is used on Add On highway boards and peg sets. Pair.



39-1536IM Male Mount Adapter \$15.95

Replacement chrome male mount adapter for use on Add On part 18548C. Pair.



GENERAL

501-113A Trunk Rack Pads \$13.95

The set consists of 4 chrome star washers and 4 black rubber washers and is ideal for mounting trunk racks or rails onto the bike. Each measures 1 1/2 inches in diameter. 4 Pack.



501-113R Replacement Rubber Washer \$.95 Single.

Snap Caps \$8.95

The chrome ABS snap caps cover the screw giving the bike a more finished show bike look. Includes 10 chrome caps and 10 liners. 10 Pack.

Part	Size Screw
252-214	#6
252-212	#8
252-213	#10



GR-300 Reusable Snaps \$7.95

This is a replacement reusable snap for the fairing and other areas on the bike. Every mechanic and do it yourself person needs to have extras in their garage. Fits the GL1800. 10 pack.



Chrome Steel Plugs

The chrome steel plugs fit the screw giving the bike a finished, show bike look.

Part	Description	Price
252-215	1/4" Screws 10 pack	\$13.95
252-216	3/4" Screws 4 pack	\$13.95
252-217	3/8" Screws 10 pack	\$17.95



678-836 Trunk Rack Kit \$9.95

A universal trunk rack kit can be used for mounting luggage racks or rails on any bike, trike or trailer. The set has 4 each of 3/4 inch washers, 3/4 inch dome washers, 1 1/4 inch Allen head screws and 8 of the 3/4 inch rubber pads. 4 pack.



14984 License Fasten Kit \$8.95

This kit makes it easy to attach license plates and gives it that finished look with chrome snaps. The kit comes with 4 theft resistant chrome caps, bolts and nuts. Single.



Grommets These replacement round rubber grommets are a necessity for every mechanic and do it yourself person.

Part	Description	Price
GR-100	Side Cover GL1000 to GL1800 & other Honda street bikes, 10 pack	\$5.95
GR-200	Oval GL1500 & GL1800 10 pack	\$5.95
GR-400	Slotted GL1800, 10 pack	\$10.95
GR-500	Assorted GL1800 side cover, 4 oval, 4 round, 2 slotted, 10 pack	\$7.95
GR-600	Side Cover GL1500 4 small oval, 4 large oval, 2 round, 8 pack	\$10.95
GR-700	Front Fender Cover GL1500 & others bikes 10 pack	\$7.95



501-113 Star Washers \$21.95

The tri-chromed metal washers have a raised star design. Measures 1 1/2 inches in diameter. 10 Pack.



45-6650-10 1/4" Chrome Plugs \$5.95

The chrome ABS caps fill in the 1/4 inch or 6 mm Allen head screw opening. They provide a smooth chrome finish to give a polished look to the bike. Great for show bikes. 10 Pack.



HST-2 Side Cover Repair Stud Kit \$36.95

Made in the U.S.A. These are high quality replacement studs perfect for Honda street and touring bikes. Includes 2 studs measuring about 2 3/4 inches in length and 9/16 inch diameter. They can be easily cut or filed down to obtain the length required for the repair work. Adhesive is included for mounting the studs onto the side covers. It is recommended that new grommets be purchased for a good hold if the original ones are in poor condition. Pair.



8265-S J-B Weld Only \$7.95 Single.

HST-2A Side Cover Studs \$26.95

Made in the U.S.A. Two studs measuring about 2 3/4 inches in length and 9/16 inch diameter. Easy to cut or file down to desired length. It is recommended that new grommets be purchased for a good hold if the original ones are in poor condition. Pair.



GENERAL

M60-6611 Adjustable Blind Spot Mirror \$12.95

This large rear view mirror optimizes your viewing for a safer ride. The mirror is on a swivel to angle as needed. Easy to install with a universal mount or can be permanently attached to the bike's rear view mirror. Available in flat black only. Single.



QR-1 Helmet Quick Release \$8.95

The reliable, fast and convenient way to securely fasten and unfasten your safety helmet chin-strap. Constructed of tempered steel and high impact nylon. It has a metal to metal Echo design locking feature which requires pressure from BOTH sides to release. Fits most helmets. Single.



Helmet Lock Extensions

Tri-chromed helmet lock extensions slip through the D-ring on your helmet to make it easier to attach the helmet to the helmet holder latch under the trunk. A more convenient way to stow the helmet.

Part	Description	Price
77-6021	Bike 3 1/2" x 2 1/2" Single	\$8.95
77-6022	Trailer 3 1/2" x 2 1/2" Single	\$8.95
993-135	Plain 3 1/2" x 1 1/2" Pair	\$10.95
993-136	Nolan 4" x 1 1/2" Pair	\$14.95

V599 Rear View Mirror \$3.95

The universal small rear view mirror measures 2 1/8 inches x 1 1/2 inches x 3/4 inches and attaches directly to the bike mirrors using self-adhesive tape. It is angled to provide additional viewing towards the rear of the bike. Single.



HV-800 Helmet Sun Visor \$11.99

By J&M®. This black visor has a smooth contoured look and gives the appearance of being part of the helmet. The 3 snap mounting is invisible giving the helmet a more custom look. Single.



38949 Black Widow Adhesive \$2.95

Black Widow is a trusted brand and made in the U.S.A. Clear adhesive is more water resistant than most on the market and can be used on any surface. Packaged in 3 gram tubes for ease of use, more control and fewer wasted tubes. Single.



RTV-1 Silicone Adhesive/Sealant \$4.95

This quality silicone adhesive comes in a .85 ounce tube. It is a convenient size and easy to use. Single.



FK-104 First Aid Kit \$34.95

Kit comes in a plastic waterproof box measuring 6 x 5 1/4 x 2 1/4 inches. Contains all of the essentials needed to take care of minor medical needs. Small and great for traveling.



77-6021



77-6022



993-135



993-136

20-64A7R Red LED Rotating Screw Light \$17.95

LEDs continually flash in a circular motion. Chrome housing, 1" diameter. Single.



28-6017LED LED Chrome License Frame \$84.95

This is a beautiful chromed steel license frame with 21 red LED lights functioning as a running and brake light for added visibility. There are also 2 white LEDs on the inside of the frame to shine onto the license plate. It comes with interchangeable red and clear lenses. Measures 7 3/16 inches x 4 1/4 inches inside the frame. Includes chrome hardware and has an 18 inch lead wire. Outside measures 7 1/8 inches x 5 inches. Single.



86-42671 Chrome with Gold Eagle License Frame \$59.95

The chrome license plate frame has gold embellishments with a gold eagle and the words "Eagle Spirit" on the top. There is a gold decorative design on the bottom. The frame measures 7 1/4 inches x 5 inches on the outside and 6 3/8 inches x 3 1/4 inches on the inside. Single.



LIGHTS



GL1800 LED Driving Lights.

Well worth the purchase for safety and brightness. Plug n play units with a relay and jumper plugs. The lights fit behind the cowl and go through the knock outs. 12 volt system. Pair.



Part	Fitment		Price
GL18RFL	GL1800 12 & up/F6B Rectangular with Running and Turn Signal function - SoCalMotogear	Fog: 900LM, 420LM, DRL: 90-450LM	\$299.95
45-1860 NEW	GL1800 01-10 Round with Running and Turn Signal function	Initial Lumens 800LM, Mean Lumens, 420LM	\$329.95
45-1860AB NEW	GL1800 01-10 Round Airbag with Running and Turn Signal function	Initial Lumens 800LM, Mean Lumens, 420LM	\$329.95
45-1850	GL1800 01-10 Round	4500 lumens	\$299.95
45-1850AB	GL1800 01-10 Round Airbag	4500 lumens	\$299.95

LED Driving Light Replacement Parts.

Part	Description	Price
45-1850-L	GL1800 01-10 Replacement LED Fog Light for 45-1850 & 45-1850AB	\$99.95
45-1850-R	Replacement Relay 45-1850/AB & 45-1860/AB	\$9.95
45-1860-L	Left Replacement LED Fog Light for 45-1860	\$104.95
45-1860-R	Right Replacement LED Fog Light for 45-1860	\$104.95



18673-221A GL1800 Xenon Blue Driving Light Kit \$99.95

These driving lights are economically priced. The kit includes 55 watts of high output halogen lights, relay switch and wiring kit. The lights fit behind the cowl and add extra road light for safety. Fits GL1800 and with the 2012 and later models, looks best with the chrome lower front cowls with round holes. Pair.

KY-938-2LK Replacement Light \$65.95

LED Strip Lights 5 Meter (16.4 feet) Roll \$110.95

This convenient roll of LED strip lights are for the do-it-yourself person who wants to customize the lights. The waterproof lights are encased in a black soft flexible housing with self adhesive tape for mounting. 1/2" light spacing, 1/4" wide, 1/16" thick, 3 lights every 2", 18 lights per foot. Great for customizing any bike, trike or trailer. Cut between the copper connectors trailer. The light has a single function operation. Roll of 16.4 feet.

Part	Color
20-64B3A-5	Amber
20-64B3L-5	Blue
20-64B3R-5	Red
20-64B3W-5	White
20-64B3-W	
Easy Clip Connector \$2.95	

Easy to connect wires and copper element in the strip lights. Single.

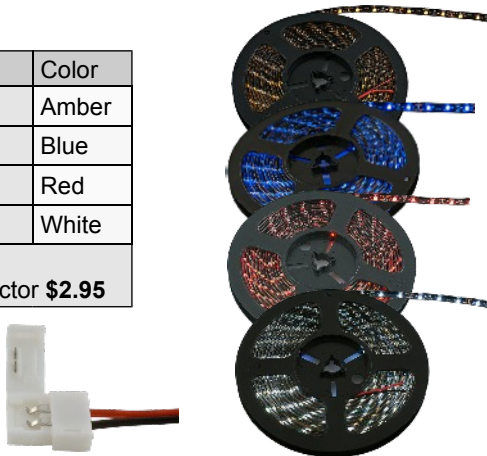

15993-119 Driving Light Bar \$61.95

Tri-chromed bar mounts to the lower fairing bolts and adds more lighting to the front of the bike for more visibility and safety. Fits all GL1500s. Single.



V562-1 Clear Driving Lights \$61.95

Universal 12 volt driving lights can be used for many applications on bikes, trikes or trailers. Each light measures 5 1/2 inches x 3 inches and is encased in a chrome housing and bezel. The lights have universal mounting brackets and include wiring and relay switch for easy installation. Pair.



Part	Replacement Bulb	Unit	Price
01-H3	55W Bulb	Ea	\$9.95
01-4530BLB	55W Super White	Ea	\$19.95
H3C50W	H3C LED - H3	Pr	\$64.95

LIGHTS



Flexible LED Soft Strip Light \$26.95

The light strip encases the LEDs in a soft black flexible thin housing. Each 12 inch strip contains 12 LED lights and has a 22 inch lead wire and connector. Easy to use on any part of a bike, trike or trailer to add custom lighting. This series of lights interconnect to provide any desired length or combination of colors. Uses two-sided tape for mounting and functions as a running or brake light. Single.

Part	Color
20-64A5A-30	Amber
20-64A5G-30	Green
20-64A5L-30	Blue
20-64A5R-30	Red
20-64A5-W	Connector \$9.95



Extreme LED Strip Light \$37.95

By Vista Mfg. Made in the USA. Strip light contains 16 bright LED lights, with a clear lens contained in a channel with chrome tips. Mounts on any flat surface with 2 screws. The light can be used as a running, brake or turn signal. 13 inches long with a 12 inch lead wire. Single. (Special order, allow 30 day lead for ordering)

Part	Color
420-411-A	Amber
420-411-G	Green
420-411-L	Blue
420-411-P	Purple
420-411-R	Red
420-411-W	White



Super Slim Side Emitting Flexible LED Strip Lights \$60.95

Side emitting flexible LED strip lights are super thin and super flexible making them perfect for a large variety of lighting applications. The unique right angle mounted LED's focus light at a 90° angle making them more visible. The waterproof lights have 48 LEDs each encased in a black soft flexible housing. Great for customizing the bike, trike or trailer. Can be cut between the copper connectors. Measures 19 inches in length, 3/16 inches in width and less than 1/16 inch in depth. Includes 35 inch heavy duty gauge lead wires and uses 3M adhesive tape to mount. Single function light. Left and right pair.

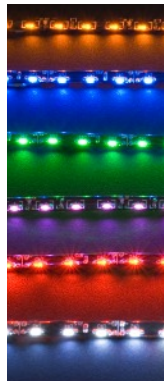

Part	Color
335A48	Amber
335B48	Blue
335G48	Green

Part	Color
335R48	Red
335W48	White

15673-224 Amber Strip Lights \$69.95 By Vista Mfg. Made in the USA. Colorful 30 inch strip lights with 23 lights each. Other colors are special order items only. They are ideal for GL1500 rotor covers or on front fender rails. Has 36 inch lead wire. Pair. (Allow 30 day lead time for ordering)



GL18BR Under Mirror Mount Brackets \$54.95

By SoCal Motogear. Brackets use existing hardware to mount lights under front directional lights. Works with most lights. Fits the GL1800 and F6B. Pair.



Strip Light in Channel By Vista Mfg. Made in the USA. The strip light is encased in a chrome channel for easy mounting on any flat surface with 2 screws and adds a decorative look to the bike. The lights have 3 inch spacing and includes a 12 inch lead wire. These quality lights have extended lamp life and lower amp draw. Works as a running, brake or turn signal light. Single.

Part Red	Part Amber	Size	Price
420-410-6	420-410A-6	6"	\$10.95
420-410-9	420-410A-9	9"	\$10.95
420-410-12	420-410A-12	12"	\$15.95
420-410-20	420-410A-20	20"	\$25.95



12-6100RR Oval LED Light \$14.95

The LED light has a beautiful chrome bezel surrounding an oval light with a red lens. The light has 8 LEDs and can be used on any bike, trike or trailer as a running or brake light. The light is a replacement for Add On LED Lighted Mud Flaps parts 741-179, 15741-179, 3741-179 and 18741-179. Measures 7" x 2". Single.



Light Clamps Die cast chrome clamps are used for a variety of application in light attachments. Single.

Part	Size	Price
998-128	3 Piece 1" Bar	\$17.95
998-129	3 Piece 1 1/2" Bar	\$17.95
998-138	1/2" or 5/8" Rail Bar	\$11.95
998-136	5/8" Rail Bar	\$5.95



LIGHTS



Flexible LED Strip Light \$26.95

These LED strip lights are both versatile and extremely flexible allowing it to be used in many places on a bike, trike or trailer. Each light contains 30 LEDs in a clear housing, measures 12 inches in length and has a 40 inch lead wire. The lights can be connected together to obtain any length desired. Mounts with self-adhesive tape. It has a two-wire function to work as a running, brake or turn signal light. Single.

Part	Description
45-1205B	Amber
20-64A6R-30	Red



LED Reflector Light \$21.95

This LED reflector light has 15 bright lights encased in a chrome housing. Measures 1 1/4 inch x 3 1/2 inch. Single wire functions as running or brake light. Single.

Part	Description
45-1227A	Amber
45-1227R	Red

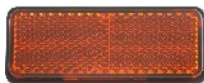

45-1227 Amber Reflector w/Screw Mount \$19.95

This amber reflector is an OEM replacement for the GL1800 Caliper Cover. Encased in a black housing. Measures 1 1/4 inch x 3 1/2 inch. Single.

Part	Replacement Lens \$4.95 Pair.
423-161AL	Amber Add On Parts 18-625A, 45-1227A, 45-1227R, 45-1227 and GL1200 side light.
423-161RL	Red Add On Parts 18-625A, 45-1227A, 45-1227R, 45-1227 and GL1200 side light.

45-1100 Raised Grills \$14.95

This chrome grill fits a light measuring 1 1/2 inches x 3 1/2 inches. Uses self adhesive tape. Also fits Add On 18-625A and GL1200 side light. Pair.



20-67A1A Amber LED Pyramid Side Marker \$29.95

The pyramid shaped lights are encased in a chrome housing with clear lenses containing 6 super bright amber LEDs each. They have a universal fit to work on any flat surface and mounts with self adhesive tape. Measure 4 x 1 1/4 inches with a 36 inch lead wire. Functions as running or turn signal light. Pair.



LED Side Marker Light with Brackets \$41.95

An attractive unique LED side marker light comes with a swivel bracket allowing the light to be directed to the angle needed. This universal light is very versatile and can be used in many different ways on the bike, trike or trailer. Each light contains 12 LED lights encased in a chrome housing. The bracket is black and can be removed if desired. Measures 6 5/8 inches x 7/8 inch. Pair.

Part	Color
L22-6510A	Amber
L22-6510R	Red



20-64B2 Amber LED Windshield Edge Lights \$59.95

The lights add an amber glow to the edge of the windshield. (May not work on aftermarket windshields.) Each kit has two strip lights containing 9 amber LEDs each, chrome channels measuring 5 inches with a 1/4 inch opening for the strip light, set screws and 36 inch lead wire. Functions as a running light or turn signal. Pair.



45-6905RLED LED Super Marker \$22.95

This classic retro domed light has been updated with 16 red LED lights. The light is encased in a chrome housing and comes with both a clear and red lens to provide you with a choice of looks. Can be used as running, brake or turn signal on any bike, trike or trailer. Measures 3 3/4 inches x 2 1/2 inches with a 36 inch lead wire. Single.

45-6905LED-RL Replacement Red Lens \$3.95



V391C Interior Light \$14.95

Interior light is for the trunk of most bikes. Easy to install. Wires into a 12V system, with a nylon switch for easy on and off operation, metal housing and mounts with screws on a 3 1/2 inch center. Separate ground and lead wires are supplied for electrical connection. Measures 1 3/4 inches x 3 1/2 inches x 4 9/16 inches. Single.



LED Arrow Lights \$14.95

The lights have 9 LED bulbs and have a 2 wire function for either brake, running or turn signal. Flashes automatically when wired into the turn signal. Measures 2 1/4 inches x 1 1/2 inches, is encased in a clear housing and mounts to any flat surface with self adhesive tape. Pair.

Part	Color
20-64A8A	Amber
20-64A8R	Red



LIGHTS



Courtesy Light \$17.95

This courtesy light pod has 4 bright LED lights encased in a chrome oval housing. It has a variety of uses and applications. Mounts to any flat surface with self-adhesive tape, includes 2 screws and nuts, measures 1 1/2 inches x 3/8 inch x 1/2 inch and has a 48 inch lead wire. Single.

Part	Color
20-6811CA	Amber
20-6811CL	Blue
20-6811CF	Flashing Multi
20-6811CR	Red
20-6811CW	White
20-6811RALH	Red Amber Blue

20-6813-S Chrome Housing for Courtesy Light \$10.95

Made for the 4 LED Courtesy Light, series part 20-6811C_ and 18-113 series fork lights. Chrome screws provided to attach the light into the housing. The base is a thread stud mount with an anti-vibration rubber washer. Single.



Ring Puk \$19.95

Round lights have 10 LEDs giving a 360° array of light. Measures 1 1/2



inches in diameter, chrome housing, mounts with self-adhesive tape and comes with a 36 inch lead wire. Single.

Part	RingPuk Color
102-A	Amber
102-B	Blue
102-F	Flashing \$23.95
102-W	White

LED Armrest Light Kit \$59.95

Adds extra lights and visibility to the side of the bike. Mounts to the armrest plate with self-adhesive tape, includes star washers for a decorative touch. Fits GL1800 and GL1500 with armrests. Pair.

Part	Armrest Color
104-A	Amber
104-B	Blue
104-F	Flashing \$61.95
104-W	White



Cluster Lazer \$14.95

The light pod has 6 bright LED lights encased in a chrome oval housing. Multi use, mounts on any flat surface with self-adhesive tape, includes screws and nuts, measures 1 3/4 inches and 36 inch lead wire. Single.



Part	Color
103-A	Amber
103-B	Blue

388-137 Super Marker Light \$11.95

The red super marker light is universal and has many light applications which are great for any bike, trike or trailer. The light is encased in a chrome housing, has a screw mount, measures 3 3/4 inch x 2 1/2 inch with a 10 inch lead wire. Single.

388-137



679-031

Optional Part	Description	Price
388-137AL	Amber Lens Single	\$3.95
679-031	Raised Grill Single	\$4.95
01-194	Replacement Bulb	\$0.98



348-137A



679-033

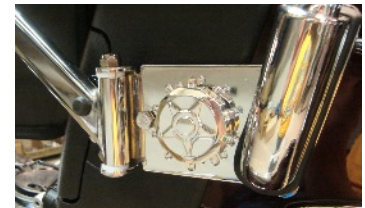

Dual Puk \$19.95

Rectangular shaped light with 10 LEDs, 5 on each side. Encased in a black housing.

Part	Color
101-A	Amber
101-B	Blue

Angled bulbs give a larger array of light. Measures 2 inches x 1 3/8 inches and has a 36 inch lead wire. Single.



348-137A Mini Tour Light \$12.95

Red mini tour light can be used in many applications such as fork lights, light bars, marker lights and more. Encased in a chrome housing it measures 1 3/4 inch x 1 inch, has a screw mount and a 10 inch lead wire. Single.

Optional Part	Description	Price
348-137AL	Amber Lens Single	\$1.95
348-137L	Red Lens Single	\$1.95
679-033	Raised Grill Single	\$4.95
01-53	Replacement Bulb	\$0.98



15993-195A Uni-Light. \$12.95 Ideal for light bars. 2 lights each. Comes with optional grill. Measures 5 1/2 inches x 2 inches. Single. Grill **679-033 \$9.95.**

45-1629LED Chrome Air Intake Grill LED Lights \$22.95

Amber LED custom light kit is used to light the air intake area on parts 45-1269NUB and 45-1629NUD fairing accents. Includes two strip lights with 3 LEDs each, measures 2 inches long and 3/8 inch wide, mounts with two-sided tape, 36 inch lead wire and has a single function application. Also, universal uses. Special order part minimum 30 day lead time. Pair.



Replacement LED Rotor Cover Lights Replacement light strips for Add On rotor cover light trims. Each has 40 LEDs. Uses self-adhesive tape to mount and has a 10 inch lead wire. Left and right pair.

Part	Description	Price
45-1222A-A	GL1800 - Amber	\$69.95
45-1222RB-A	GL1800 - Amber Red Blue	\$71.95
45-8134ALED-A	GL1500 - Amber	\$61.95
45-8134ARBLED-A	GL1500 - Amber Red Blue	\$69.95

LIGHTS



BULBS



Part	Watt-Lumens	Watt/Application/Part	Price
01-1821-1	15	Corner light 132-205A	\$0.98
01-1895	3	Spoiler light 08170-MN510C	\$0.98
01-194	3	Flush light 15993-195A 08170-MN540, 388-137	\$0.98
01-194A	3	Side Reflector 08170-MN530, 45-8929A	\$0.98
01-4530BLB	55	H3 Super White Driving light	\$19.95
01-48328	55	H7 Headlight GL1800	\$14.95
01-48638	55	H7 Xenon Super White Headlight GL1800	\$29.95
01-53	3	Instrument, marker 131-625A, 993-194, 348-137A, 348-138A, 348-139A, 388-138	\$0.98
01-62100	100/55	H4 Headlight	\$14.95
01-6245	1/1	H4 Headlight 88-97	\$19.95
01-6245J	45/45	Corner light 15673-221B	\$2.95
01-6260	60-55	H4 Headlight 88-97	\$9.95
01-6260S	60-55	H4 Super White Headlight	\$19.95
01-6290	13/9	H4 Headlight	\$19.95
01-97	3	Rear Reflector 08170-MN520	\$0.98
01-H3	55	H3 Driving light V562-1	\$9.95
01-P7440	365/956	Rear Directional GL1800	\$2.31
01-P7443	365/956	Front Directional GL1800	\$2.31
1157A	450LM	1157 LED replacement Amber Pathfinder GL1500 dual filament	\$20.00
1157R	450LM	1157 LED replacement Red Pathfinder GL1500 dual filament	\$20.00
7443A	450LM	7443 LED replacement Amber Pathfinder GL1800/F6B	\$20.00
7443R	550LM	7443 LED replacement Red Pathfinder GL1800/F6B	\$20.00
AD-2011GY	365/956	Amber front directional GL1800 45-1228, 45-1228S	\$4.95
AS-35DRLED	10 LED	Red Trunk light, dual filament, GL1800	\$16.95
AS-36DWLED	13 LED	White Trunk light, dual filament, GL1800	\$18.95
G158897 NEW	4800 @ 5500K	GL1500 88-97 Low & High Headlight Bulbs PAIR	\$110.00
G159820S NEW	4800 @ 5500K	GL1500 98-00 Low & High Headlight Bulbs PAIR	\$110.00
G18LEDH NEW	4800 @ 5500K	GL1800/F6B LED High & Low Beam Headlight Kit PAIR	\$110.00
GL88NC	N/A	LED Flasher, plug n play, normalizes turn signal blinking, GL1800/F6B	\$29.99
H3C50W	500LM	H3 50W LED replacement for Honda fog light, 600K color, Pathfinder, GL1800 PAIR	\$64.95
LED-1157R	12 LED	Red Rotating tail light	\$29.95
LED-1157W	12 LED	White Tail light dual filament	\$19.95
LED-1157RED	12 LED	Red Tail light dual filament	\$19.95
L18SWB	450-500LM	Switchback LED, activates when turn signals are turned on, GL1800/F6B dual	\$27.50
LP9T10	250LM	50W LED replacement License Plate, 600K color, fit Honda and most motorcycles	\$5.95
T1050W	500LM	H3 50W LED replacement, 600K color, Pathfinder, GL1500 & other motorcycles PAIR	\$44.95
KY-401-N		H4 halogen headlight bulb shield gives off a soft colored haze for better visibility in rain and fog. Fits left or right. Single.	\$10.95

LUGGAGE/TRAVEL

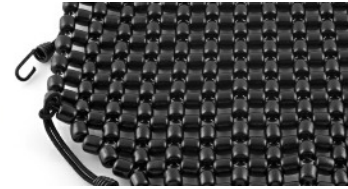

45-6965B Rain Seat Cover \$46.95

The black seat cover has an elastic edge to fit snugly over the OEM driver seat, passenger seat and passenger backrest. It is made of polyester, is UV and water repellent and is colorfast grade 4. The compact size makes it perfect for traveling and includes a carrying case. Works with or without the side mount driver backrests. This black rain seat cover measures 21 inches x 12 inches x 12 inches. Fits the GL1800s. Single.



020-1808 Folding Trunk Bag \$49.95

The folding rack bag is convenient for any type of traveling. To open, unzip and unfold to reveal a large bag that provides lots of storage room and then conveniently folds and zips down to easily stow away. The bag is made of 400 Denier nylon. When folded, it measures 13 inches x 8 1/2 inches x 3 1/2 inches and unfolds to a big measurement of 21 inches x 12 inches. Fits on most trunk racks. Features Velcro attachments, zipper closures, deluxe handles, side pockets, shoulder strap and rain cover. Single.



678-034B Black Beaded Seat Cover \$29.95

The black beaded seat cover gives a more comfortable ride by allowing air to circulate. It helps to keep you cooler in hot weather or dryer when it is raining. The larger size and rounded beads make long distance travel more enjoyable. Easy on and off with a bungee cord system with coated hooks. Measures 11 inches x 16 inches. Fits the GL1500 and GL1800 driver seats and can fit many other seat styles. Single.

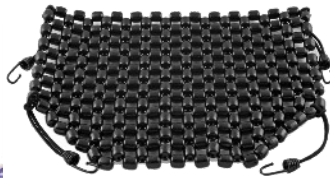

020-1800 Luggage Liner Set \$90.95

Made of black 400 Denier nylon and features zipper closures, velcro flaps, storage pocket and handles. Set consists of 2 saddlebags liners measuring 13 1/4 inch x 21 inches and 1 trunk bag measuring 13 1/4 inch x 22 inches. Fits all GL1800s.



020-1806 Deluxe Cooler Rack Bag \$50.95

Black insulated bag fits onto a cooler rack with bungees. Measures 16 inches x 10 inches x 11 inches. It features a rear storage zippered pocket with a 2 inch x 15 inch reflective strip, easy access pouch on the top, a full zipper top, and shoulder strap for carrying. Folds down for easy storage. Single.



Bungee Nets Heavy duty black nylon nets come with rubber coated hooks. Single.

Part	Size	Price
328-100B	14" x 17"	\$7.95
328-211B	40" x 50"	\$12.95
328-993	Single cord - installs with existing hardware.	\$6.95
78-07050	12" Bungee Cord - 2 double hooks	\$1.65

328-100B



328-211B

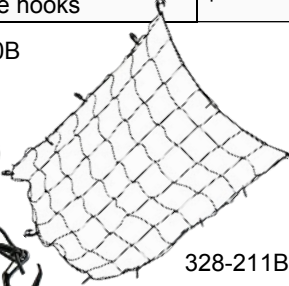

328-993



78-07050



E88-6116 Signal Magic \$19.95

Stuck at red lights waiting for the signal to change? This strong magnet will help identify your bike at a traffic light when there is an inductive loop system in the road to cause the lights to change. Will not harm on-board electronics. Measures 4 1/8" x 9/16" x 1/2". Mounts with 3M adhesive tape and wire ties. Works on any bike or trike. Single.

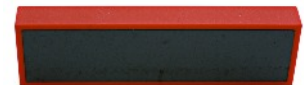

1035 Take Off Banner \$1.95

"REMOVE BEFORE TAKE OFF" This is a must for safety and an easy reminder for the driver to unlock the bike before driving off. This day-glow yellow banner measures 18 inches x 1 3/4 inches. Single.



LUGGAGE/TRAVEL

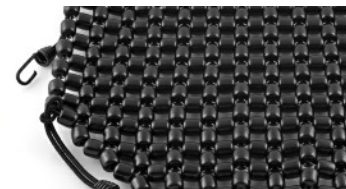

By Dowco® Bags and Covers

50125-00 Main Bag \$142.95

The main bag is the largest luggage bag in the Iron Rider® modular luggage system. It features front access pockets and expandable sides. Rigid construction allows stacking of other bags and helps bag maintain its shape. Removable molded handle, removable shoulder strap, and rain hood included. Made of 1680 Denier Polyester. The special diamond plate bottom design adds protection and a rugged look to the piece. Measures 23 x 11 ½ x 11 ½ inches. Single.



50156-00 Roll Bag \$116.95

The perfect luggage bag for all of your riding needs. Features both side and front access into the bag and pockets. Rigid construction helps bag maintain its shape. Mix and match with Iron Rider® other bags for additional storage capacity. Includes removable molded handle, shoulder strap and rain hood. Made of 1680 Denier Polyester. Measures 18 x 10 x 13 inches. Single.



26037-00 Guardian® Ultralite™ Plus \$69.95

This is a full size travel cover with compact design. It is constructed of rip-stop polyester for tear and abrasion resistance. It has UV and water repellent coatings, 2 sewn in vent flaps for allowing moisture to escape, a sewn-in storage bag and an elastic cord sewn along the bottom with belly straps. Single.



LLTLG Guardian® Traveler \$51.95

This covers the essential parts of the motorcycle; the fairing, seat and rear trunk. Made of durable urethane coated polyester, it is water repellent and quick drying. It folds compactly for storage, has a shock cord hem and foot peg straps. Great for traveling. Two year warranty from DOWCO. Single.



50084-00 Guardian® Weatherall Plus Trike Cover \$104.95

A full size trike cover constructed of heavy-duty polyester with special Color-Lok® treatment to prevent fading. Exclusive ClimaShield® Plus fabric protection, double taped seams, moisture guard vent system, heat shield, interior liner for windshield, sewn elastic shock cord and under-bike web strap, sewn in grommets, storage bag and sewn in pockets. Limited lifetime warranty from DOWCO. Single.



678-823 Chrome Coin Holder \$14.95

The tri-chromed coin holder fits on either a 7/8 inch or 1 inch handlebar. Puts change at your finger tips without digging in your pockets. Especially useful at a drive through. Single.



DW-1 Animal Whistles \$11.95

These chromed ABS whistles are intended to ward off approaching animals with a silent whistle. The chrome whistles are removable for easy cleaning and slide into a black base. They mount to any flat surface with self-adhesive tape. Pair.



AL-06 Plastic Cycle Foot \$2.95

An essential piece to carry at all times. The cycle foot provides better support for the bike when parked on soft surfaces. Made of a durable plastic to be used under the kickstand. Small and light weight, it fits easily into the trunk or saddlebag. Measures 6 ½ inches long and 3 ¾ inches across the toes. Colors: orange or black. Single.



SERVICE ACCESSORIES

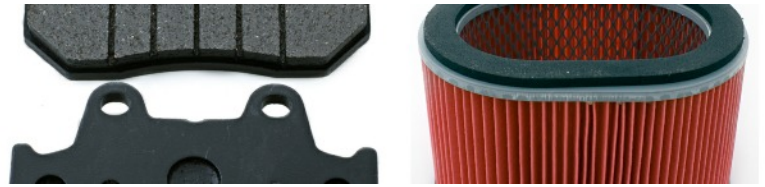

Brake Pads By EMGO	Fitment	Front	Rear	Price
91-51802	GL1000 1975-1979		X	\$19.95
91-51803	GL1000 1975-1979	X		\$19.95
91-51803	GL1100 1980	X		\$19.95
91-51805	GL1100 1980		X	\$19.95
91-51805	GL1100 1981	X	X	\$19.95
91-51807	GL1100 1982-1983		X	\$19.95
91-51808	GL1100 1982-1983	X		\$19.95
91-51826	GL1200 1984-1987	X	X	\$25.95
91-51826	GL1500 1988-2000		X	\$25.95
91-51836	GL1500 1988-2000	X		\$19.95
91-68006	GL1800 2001 & up	X	X	\$22.95
Brake Pads by EBC Kevlar	Fitment			Price
FA69-3	GL1200 1984-1987	X	X	\$41.95
FA69-3	GL1500 1988-2000		X	\$41.95
FA124-2	GL1500 1988-2000	X		\$41.95
FA261HH	GL1800 2001-2015	X	X	\$41.95



91-51802



91-51803



91-51805



91-51807



91-51808



91-51826



91-51836



91-68006



FA69-3



FA124-2



FA261HH

Oil Filters By Emgo. O.E.M. replacements.

Part	Fitment	Price
10-82240	Fits GL1800, VTX 1800, CBR600F4, CBR929RR00-01 and OEM 15410-MCJC2000	\$7.95
10-82230	Fits GL1500	\$7.95
10-37500	Fits GL1000, 1100 and 1200	\$5.95



10-82240



10-82230



10-37500

Air Filters By Emgo. O.E.M. replacements.

Part	Fitment	Price
12-90010	GL1000 1975-1979	\$13.95
12-90021	GL1200 1980-1987	\$13.95
12-90030	GL1500 1988-2000	\$29.95
12-90050	GL1800 2001 & up	\$24.95



12-90010



12-90021



12-90030



12-90050

SERVICE ACCESSORIES

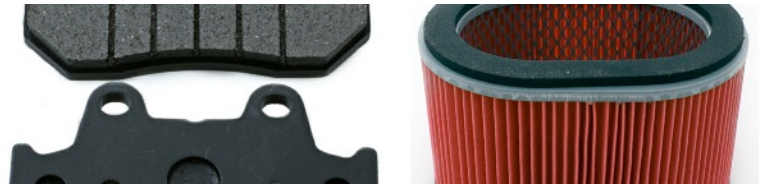

Haynes - Clymer Service Manuals by Haynes Repair manuals provide step-by-step procedures based upon the disassembly of the bike. The books are detailed and user-friendly. Hundreds of original photos and illustrations guide the reader through every job, making it easy to reduce repair costs.

Part	Application	Price
M309	Complete coverage for your Honda GL1000 Gold Wing covering 999cc models for 1975 to 1979	\$37.95
M669	Complete coverage for your Honda GL1100 Gold Wing covering 1085cc models for 1979	\$37.95
M504	GL1200 Standard (1984) GL1200A Aspencade (1984-1987) GL1200I Interstate (1984-1987) GL1200L Limited Edition (1985) GL1200SE-I Aspencade SE-i (1986)	\$49.95
M505	GL1500 Standard (1988-1990) GL1500SE SE(1990-1992) GL1500A Aspencade (1991-1992) GL1500I Interstate (1991-1992)	\$51.95
M506-2	GL1500SE Gold Wing Special Edition (1993-2000) GL1500A Gold Wing Aspencade (1993-2000) GL1500I Gold Wing Interstate (1993-2000)	\$51.95
M507-3	GL1800 Gold Wing 2001-2010	\$51.95



NEW 45-1257 GL1800 Air Filter Intake Screens \$29.95

These screens goes over the air filter intake to keep out debris and any critters wanting to make a home. Easy to install with O rings. Fits all GL1800s. Pair.



45-6017 Air Hose \$15.95

10 foot air hose with rubberized coating and a quick release connector. Universal fit. Single.



363-210 Oil Filter Bolt \$19.95

This steel bolt has a standard 17mm head and is designed as a direct replacement equivalent to Honda OEM Part # 15420-300-020. Fits on all GL1000, GL1100 and GL1200. Single.



84-27580 Filter Wrench \$16.95

Works on the GL1800, GL1500, VTR250, VT600C, PC800, VFR750, ST1100, CBR, TRANSALP. Single.



Fork Seals By K&L Supply. Made of quality pro-poly material. Pair. **Special Order.**

Part	Application	Price
15-5081	GL1800 01-10	\$40.95
15-5087	GL1200	\$39.95
15-5088	GL1100	\$39.95



08-802 Timing Belt \$65.95

By K&L Supply. Made of quality rubber. Two required when replacing. Fits GL1200. Single.



SUSPENSION



416 Series Magnumatic Air Shocks by Progressive. Over the years this shock has been improved upon and is absolutely the best crafted shock available. The air can is mated to the famous Progressive Suspension dampener units with the finest quality seals and bushings available. Easily installed airlines and fittings. Some bikes require an adapter kit to connect to the stock compressor or fill valve. Pair.

Part	Description	Price
1633GLA	GL1500 88-00	\$499.95
1626A	GL1200 84-87	\$499.95
1622A	GL1100 80-83	\$499.95
30-5082	Compressor Adaptor Kit	\$26.95
30-5086	GL1500 Compressor Adapter Kit	\$20.95
5041	416 Series Oil Seal Kit	\$29.95



412 Series By Progressive. The 412 steel spring shocks are a simple, durable design that will improve the motorcycle's suspension performance for as long as you are riding it. The double walled steel body construction with nitrogen charged, multi-staged velocity sensitive valving gives you smooth, consistent damping. A five-position cam style pre load adjuster lets you dial in your ride whether you're a light rider or heavy hitter. They have a chrome cover with black springs. Pair.

Part	Description	Price
4223C	GL1500 88-00	\$299.95
4226C	GL1200 84-87	\$299.95
4222C	GL1100 80-83	\$299.95
4224C	GL1000 75-79	\$299.95



GL1800-0 Rear Suspension Pre-load Line \$53.95

By H-E-L USA. This line replaces the factory rubber pre-load line on the rear suspension which often wears out over time preventing its proper functionality. Made of stainless steel. The kit includes a stainless steel line, stainless steel banjos and 4 copper crush washers. Requires use of original banjo bolts. Fits GL1800 01-10. Single.



All Progressive items require a 30-60 day lead time.

Fork Springs By Progressive. Have the ability to provide a plush ride over small road bumps and absorb shocks from larger ones. Developed for the Gold Wing, they can handle the loads of life longer than stock springs. They carry a lifetime warranty. Pair.



Part	Description	Price
1100	GL1000 75-79	\$99.95
1102	GL1100 80-83	\$99.95
1122	GL1200 84-87	\$99.95
1152	GL1500 88-00	\$127.95
11-1521	GL1800 01 & up	\$129.95

31-2511 GL1800 Monotube Cartridge Forks \$399.95

Progressive Suspension's state of the art Monotube Cartridge Fork Kit represents a high point of touring bike front-end handling. The kit features a set of gas charged Monotube dampers and a pair of Gold Wing proven custom tuned fork springs and replaces the antiquated open bath internals of the stock fork. Results - improves ride comfort, front end stability, cornering and bottoming control. Replaces most of the internal parts of the fork. No mods are required to install and it retains the factory anti-dive function. Limited lifetime warranty. Fits all GL1800 and F6B. Pair.



01-1179B GL1800 Rear Shock Spring \$97.95 By Progressive. This heavy duty rear shock spring is designed to replace the stock shock spring. Strong for the heavy loads. Fits all GL1800s. Single.



12-1206B Trike Shock Dampers \$203.95

By Progressive. Dampers only for heavy duty shocks. Sold without springs and covers. See Progressive for spring application. Pair. Special Order



03-1368B Black Shock Springs \$76.95

By Progressive. Rated 105/150. Fits 12 1/2", 13", 13 1/2", 14 1/4" lengths. Pair. Special Order.

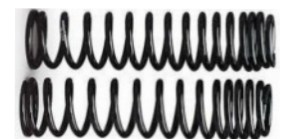

Mini Gauge Pump \$54.95 By Progressive®, the mini gauge pump is a handy source for checking and adjusting pressure in your forks and air shocks. The unit comes complete with flexible hose and integral gauge. Double "O" connector. Single.



Part	Description
GP3-30	0-30 PSI
GP3-60	0-60 PSI
GP3-100	0-100 PSI

TRAILER ACCESSORIES

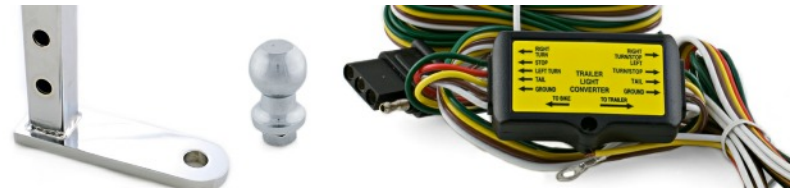

Trailer Hitches All include hardware necessary for assembly.

45-1806 GL1800 Receiver Hitch \$244.95

This receiver trailer hitch is easy to install and allows the rear wheel section to be removed in one piece. The trailer hitch includes an H bracket, 2 arms, chrome 1 1/4 inch receiver with a 6 3/4 inch chrome tongue, clip and pin to attach the receiver and a 1 7/8 inch chrome ball. Fits the GL1800 01-10 except airbag models. Single.



45-1806A GL1800 Receiver Hitch \$244.95

This receiver trailer hitch is easy to install and allows the rear wheel section to be removed in one piece. Includes an H bracket, 2 arms, chrome 1 1/4 inch receiver with a 10 inch tongue, clip and pin and 1 7/8 inch chrome ball. Fits the GL1800 12 & up except airbag models. Single.



993-181 GL1100/GL1200 Trailer Hitch \$159.95

The trailer hitch is made of steel, has a chrome plate to hold the ball and includes all necessary mounting brackets and hardware to mount onto the bike including a 1 7/8 inch chrome trailer ball. Fits the GL1100 and GL1200 except for the 84 and 85 Aspencade which needs a modification to the bracket. Single.

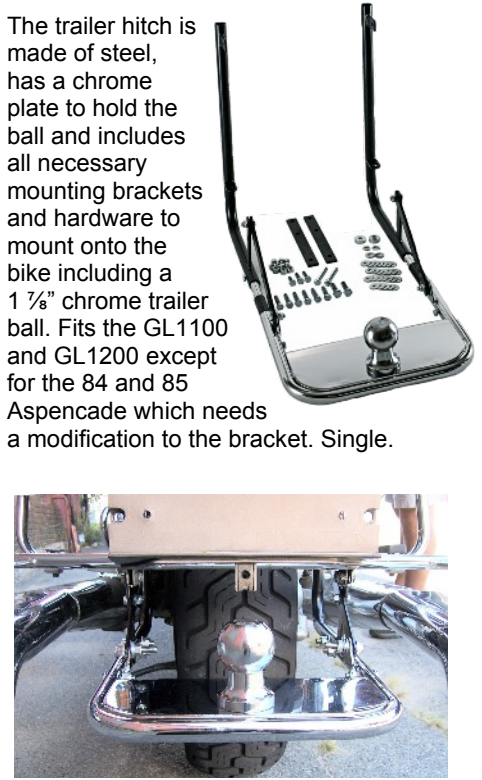

673-181 Chrome Trailer Ball Cover \$11.95

Tri-chromed trailer ball cover fits over a 1 7/8 to 2 inch trailer ball and includes a foam insert to hold the cover in place. Single.



993-181A Chrome Trailer Ball \$22.95

The standard chrome trailer ball measures 1 7/8 inch and can be used as a replacement for any trailer hitch. Single.



45-1848 Trailer Wire Harness Converter \$18.95

The wire harness converter allows the connection of 5 wires from the bike to a trailer with a 4 wire system.



45-1806-A GL1800 01-10 Replacement Chrome Receiver, Pin & Clip \$41.95

Replacement tri-chrome 1 inch receiver, pin and clip. Fits the GL1800 01-10. Single.



678-038 Chrome Jack Stand \$48.95

A chrome trailer jack stand attaches to the tongue of the trailer. It is spring loaded and is easily pulled down into position to balance the trailer. It flips up out of the way when not in use. Single.



45-1806-C GL1800 2012 & up Replacement Chrome Receiver, Pin and Clip \$54.95

Replacement tri-chrome 1 inch receiver, pin and clip. Made with a longer reinforced receiver to fit the newer GL1800s. Fits the GL1800 12 & up. Single.



TRAILER ACCESSORIES



45-1819 ABS/Non-ABS Isolated Trailer Wire Harness \$39.95

Trailer wire harness allows the current from the trailer lights to be drawn directly from the battery using stock lighting circuits. Fits the GL1800 01-10.



090-143T Non-ABS Brake Trailer Wire Harness \$18.95

Trailer wire harness allows the current from the trailer lights to be drawn directly from the bike battery. Fits the GL1800 01-10 with Non-ABS brakes.



45-1896 Isolated Trailer Wire Harness \$54.95

A plug and play all inclusive isolated trailer wire harness. Fits the GL1800 12 & up.



358 Trailer Wire Connector Kit \$45.95

Universal chrome trailer wire connector consists of a 6 pin contact, waterproof socket and plug-in receptacle. Single.



45-8945 Trailer Wire Harness with Relay \$35.95

A plug and play trailer wire harness with relays allows the current from the trailer lights to be drawn directly from the battery using stock lighting circuits. Fits the GL1500.



Cooler Racks These cooler racks are well engineered to carry heavy loads and are constructed of light weight durable aluminum that will not rust. This rack has a receiver with a 1 ¼ inch opening. The rack comes in a natural finish or painted black, measures 11 inches by 16 inches with a solid 1 inch frame edge with holes to attach bungee cords and a grate floor. Made in the U.S.A. Single.

Part	Color	Application	Price
678-032	Natural	Adjustable cooler rack for any horizontal receiver. Can adjust from 4 ¼" to 8 ¼".	\$169.95
678-032B	Black	Adjustable cooler rack for any horizontal receiver. Can adjust from 4 ¼" to 8 ¼".	\$169.95
678-036	Natural	GL1800 01-10 Vertical	\$153.95
678-036B	Black	GL1800 01-10 Vertical	\$153.95
678-037	Natural	GL1500 Horizontal	\$153.95
678-037B	Black	GL1500 Horizontal	\$153.95
678-039	Natural	GL1800 12 & up Vertical	\$153.95
678-039B	Black	GL1800 12 & up Vertical	\$153.95

678-032



678-037

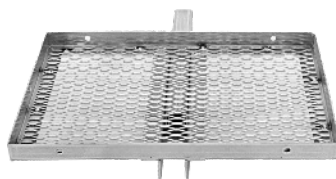

678-036

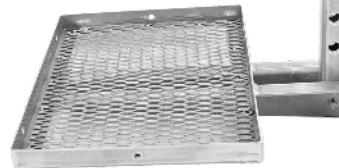

678-039



678-032B



678-037B



678-036B



678-039B



TRAILER ACCESSORIES

Chrome Trim Great for adding chrome accents to the bike, trike, or trailer. Self-adhesive, flexible and comes in rolls.

Part	Description	Price
S37734	3/4" x 12' Body Molding	\$36.95
T3605 C	3/8" x 18' Wheel Well	\$29.95

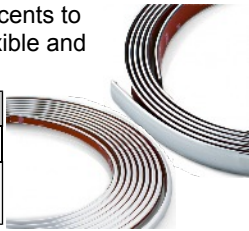

LED Side Marker Lights With Brackets \$41.95

14 LEDs with swivel bracket to angle as needed. Use as a running or brake light. Measures 6 5/8 inches x 7/8 inch. Pair.



L22-6510A



L22-6510R

L22-6510A	Amber
L22-6510R	Red

45-6905RLED LED Marker Lights \$22.95

This classic retro domed light has 16 red LED lights. The light is encased in a chrome housing and comes with both a clear and a red lens. Single.



45-6905LED-RL \$3.95 Replacement Red

15993-195A Uni-Light. \$12.95 Ideal for light bars. 2 lights each. Comes with optional grill. Measures 5 1/2 inches x 2 inches. Single.



Grill 679-033 \$9.95.

12-6100RR Red Oval LED \$14.95

The light has 8 LEDs with a red lens and a chrome housing. Can be used on any bike, trike, or trailer as a running or brake light. Measures 7 inches x 2 inches. Single.



CAN-AM

46-1000 Can-Am Chrome Handlebar Top Cover \$127.95

Beautiful tri-chromed ABS top handlebar cover is an economical way to add a great chrome accent to the dash of the bike. Attaches with self-adhesive tape or silicone. Fits the Can-Am® RT model only. Single.



46-1002

Chrome Decal \$9.95

The chrome round disc measures 2 3/4 inches in diameter and is embossed with a gold eagle. Uses self adhesive tape to mount onto any flat surface and is a perfect fit for the front or rear on the Can Am®. Single.



Part	Color
46-1002	Gold Eagle
46-1002B	Black Eagle



46-1002B

REFERENCE

GL1800	1-24	C		Fork Bridge	26
GL1500	25-38	Caliper Cover	1, 39	Fork Cover	1, 26
GL1200-GL1000	39-45	Cam End Cover	30	Fork Lights	1
J&M Audio	46-52	CanAm	57, 75	Fork Seals	71
Apparel/Novelty	53	Carburetor Cover	30, 41	Frame Cover	10
Electrical	54-55	Carpet Set	21	Fuel Door	15, 34
Emblems/Trim	56-57	Case Guard	6, 27	Fuse Kit	54
Flagpole Kits	58	CB Antenna	18, 35, 44, 50, 51	G	
Footrests	59-60	CB Accessories	13, 30, 44, 50-51	Glove Box	15, 33
General	61-62	Chrome Nuts	53	GPS Mount	13
Lights	63-67	Cigarette Lighter Socket	16, 54	Grills	
Luggage/Travel	68-69	Clothing	53	Fairing	7, 26
Service Accessories	70-71	Clutch	12, 32, 42	Light	1,14,19,21,27,65,66
Suspension	72	Coin Holder	69	Radiator	6, 26
Trailer Accessories	73-75	Cooler Rack	23, 38, 74	Reflector	1, 21, 24, 38, 65
CanAm	75	Cowl	26	Saddlebag	19, 21
A		Cycle Foot	69	Speaker	16, 17, 34, 36, 43
Accessory Switches	11,12,16, 33, 54, 55	D		Trunk	19
Adhesive	9, 31, 41, 61, 62	Dash	15, 16, 33, 34, 43	Turnsignal	21
Air Filter	70	Drink Holder	13, 17, 33, 35, 43	Grips	12, 32, 42
Air Hose	71	Driver		Grommets	61
Air Horn	55	Backrests	16, 35, 44	H	
Air Intake	4, 6, 7, 15, 71	Boards	8, 9, 29, 41	Halo Lights	3
Air Pump	72	Driving Lights & Directional's	2,14,26,27,39,63	Hard Pocket	33
Air Vent/Accents	5, 27, 28, 30, 34, 39	E		Hand Warmer	12, 32
Animal Whistle	69	Electrical	11, 24, 54-55, 63	Handlebar Clamp	13, 33, 42, 43
Antenna	18, 35, 44, 50, 51	Emblems	5, 16, 17, 20, 24, 38, 45, 56, 57, 75	Headlight	
Apparel	53	Engine		Accent	4
Arm Rests	17, 35, 44	Side	9, 10, 30, 31	Bulb	3, 27, 67
Audio Cords	46-50	Engine Plate	6, 29	Knob	34
B		Exhaust Extension	20, 38	Visor	40
BackRests	16, 35, 44	F		Headsets	46-48
Battery Tender	55	Fairing Accents	6-8, 15, 27, 30, 39	Helmet Accessories	12, 20, 33, 37, 43, 52, 62
Beaded Seat Cover	16, 35, 68	Fender		Highway	
Belt Buckle	53	Extension	3, 26, 39	Boards	8, 9, 29, 59
Bike Cover	17, 68, 69	Light	3, 21, 25	Mounts	8, 9, 29, 41, 59, 60
Bluetooth	48, 49	Trim/Side Cover	3, 21, 23, 25, 39, 56	Peg	8, 9, 29, 41, 59, 60
Brake		Filter Wrench	71	Horns	44, 55
Pedal	9, 60	First Aid Kit	62	J	
Lever	12, 32, 42	Flagpole Kits	58	J&M Parts	46-52
Lights	20,38,45,62, 67, 75	Floorboard Sets	8, 9, 29, 41	Jumper Cable	55
Pad	41, 60	Fog Lights	2, 63	Jack Stand	73
Bulb	2, 3, 14, 20, 26-28, 36-40, 43, 45,63,67	Foot Pad	60	K	
Bungee Cords/Nets	68	Footrests	8, 9, 11, 29, 59, 60	Key Accent	15, 34

REFERENCE

Kickstand	9, 41	1500	38	Service Manual	71
Kill Switch Cover	13, 32	Trike	24, 38, 45	Service Parts	70-71
L		Universal	45	Shifter	8, 9, 29, 41, 60
Levers	12, 32, 42	N		Shirts	53
License Frames	21,38,61, 62	Novelty	53	Shocks	72
Lights		O		Side Accents	4, 6, 7, 10, 27, 30, 31, 40
Armrest	16, 17, 35, 66	Oil Filter	70	Side Covers	10, 31
Brake	16,17,20 ,21, 38, 45, 62, 67	Oil Filter Bolt	39, 71	Signal Magic	68
Bulb	2, 3, 14, 20, 26, 27,28 36-40, 43, 45, 63, 67	P		Snap Caps	61
Caliper	1	Passenger		Snow Globe	53
Cluster	66	Armrest	16, 17, 35, 44	Speakers	18, 36, 52
Corner	27, 43, 67	Audio	48	Star Washers	18, 36, 61
Courtesy	1, 66	Drink Holder	17, 35, 43	Suspension	72
Directional	2,7,14,16,17,20,27,28 36,38,43,63,65,67	Floorboards	10, 11	T	
Driving & Fog	2,14,26,27,39,63,67	Pegs	11	Take Off Banner	68
Fairing	6,7,27,28,40	Pegs	8, 11, 29, 59, 60	Throttle Rest	12, 32, 42
Fender	3, 21, 25	Pins	53	Timing Chain Cover	3
Fork	1	Plugs	9, 25, 43, 61	Trailer Accessories	22, 45, 73-75
Halo	3	Progressive	72	Trailer Hitch	22, 45, 73
Headlight	3, 4, 27, 67	Q		Trim	10, 24, 57, 75
LED	1-7,14, 16-18, 20, 21 23-28, 35, 38-40, 45, 62-67,75	Quick Release	62	Trunk	
Light Ring	1	R		Accent	19, 20, 36, 61
Marker	40, 65, 66, 75	Radiator Grill	6, 26	Bag	68, 69
Mini Tour	66	Radio		Grills	19
Mirror	14, 65	Accent	15, 16, 34, 43, 52	Handle	19, 23, 36, 44
Mount	13, 64, 65	CB	49, 50	Light	16, 36, 37, 65
Ornament	3, 5, 20, 56, 57	Satellite	18, 51	Organizer	20, 21
Ring Puk	17, 35, 66	Rain Seat Cover	17, 68	Rack	18, 23, 36, 44
Rotor Cover	1, 25	Rain Deflector	6, 8	Relocation	44, 50
Saddlebag	20, 37, 45	Rear Door Accent	17, 36	Tunnel Filler	3, 26
Side	1,4,6,7,35-37,40,65	Reflectors	5, 19, 38, 65	Turnsignal	
Speaker	18	Relay Switch	2, 63	Bulb	20, 27, 67
Spoiler	17	Remote Cover	15	Light	2,4,6,7,16,17, 20 27,28,43
Strip	4,23,25,39,63-66	Repair Studs	9, 31, 41, 61	V	
Trunk	20, 36, 37, 63-67	Reverse Lever Acct	30	Volt Accessories	11, 54
Windshield	4, 5, 65	Rist Rest	12, 32, 42	W	
Light Ring	1, 25, 66	Rock Guard	45	Washers - Star	18, 36, 61
Luggage	21, 68, 69	Rotor Covers	1, 25	Wind Deflector	5, 6, 8, 26, 32 40, 42
M		S		Windshield Accent	5, 24, 26
Master Cylinder	13, 33, 42	Saddlebag		Windshield Light	4, 5, 65
Mirrors/Accts/Bracket		Accent	20, 37, 45	Windshield Vent	5, 26
1800	14	Bags	21, 68, 69	Windsock	50
1500	28	Grills	19, 21	Wire Connectors	24,27,54,55,63,64
1200	40	Rails	37, 45	Wire Harness	
Rear View	13, 28, 62	Scuff Covers	10, 37	Speaker	18, 36, 52
Mudflap		Sealant	61-62	Spoiler	17
1800	24	Seer Ears	52	Trailer	22, 37, 73, 74

Add On **ACCESSORIES**®

From 1975 to 2017 ...

... We've got you covered!



133 Gold Street

Worcester, MA 01608

508-791-7552 • 800-821-9861 • Fax 508-793-2919

Email: info@addonaccessories.net

www.addonaccessories.net

